

CATALOG ^{21/22}



INDEX

History 13
Heritage 29
The Green Challenge 30
Friedberg Thonet Museum 32
Products 33
Abacus 288

CHAIRS &
ARMCHAIRS



Beaulieu

36



Bistrotstuhl

42



Bodystuhl

44



Brezel

48



Caféstuhl

50



Czech

52



Czech

52



Gustav

60



Loos Café Museum

62



Magistretti 0301

64



Malit

66



Morris

68



N. 0

70



N. 0

70



N. 1

74



N. 14

76



N. 18

78



N. 811

80



Pince

84



Post Mundus

86



Postsparkasse

88



Radetzky

92



Sölden

96



Sugiloo

102



Sugiloo

102



Vienna 144

108



Wiener Stuhl

110

STOOLS



Cirque

114



N. 18 Barstool

78



N. 811 Barstool

80



Postsparkasse

88



Single Curve Stools

122



Single Curve Stools

122



Trio

128



Trio

128



Vienna 144 Hocker And Barhocker

108



BENCHES



Coat Rack Bench

118



Mos

182



Ruhering

117

LOUNGE CHAIRS & SOFAS



Chignon

132



Hideout

136



Hold On

140



Jannis

142



Lehnstuhl

150



Loie

156



N. 200

160



Promenade

164



Schaukelstuhl

168



Suzenne

170



Suzenne

170



Targa

176



Targa

176



**STORAGE
UNITS AND
BOOKCASES**



NYNY

190



NYNY

190



Mos

182



HEADBOARDS

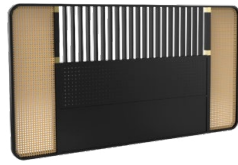

Ottow

200

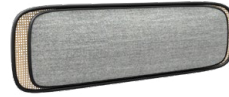

Rue

204

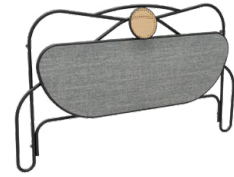

Yvette

208

DINING TABLES



Arch Dining Table

210



Caryllon Dining Tables

212



Magistretti 0302

64



Ring Dining Table

226



Säule

228



Rehbeintisch

222

BISTROT TABLES



Brandy

320



Cognac

234



Pastis

235



Porto

236



Rum

237



Sherry

238



Vermouth

240

COFFEE TABLES



Arch Coffee Table

242



Caryllon Low Tables

212



Duet

244



Duet

244



Hold On Side Table

140



Mos Side Table

182



Peers

246



Peers

246



Single Curve Low Tables

122



Wiener Box

250



DESK



Allegory Desk

254

ACCESSORIES



Arch Clothes Valet

271



Cloud

256



Eyeshine Mirrors

257



Eyeshine Mirrors

257



Feng

258



Furia

262



Kleiderständer

264



Kleiderständer P29

265



Kolo Moser

266



Ladder

268



Majordomo

270



Stocksessel

272



Wagasa

274



Waltz

276

RUGS



**Around Colors
Rugs Collection**

278

CUSHIONS



**Curved Cushions
Collection**

282

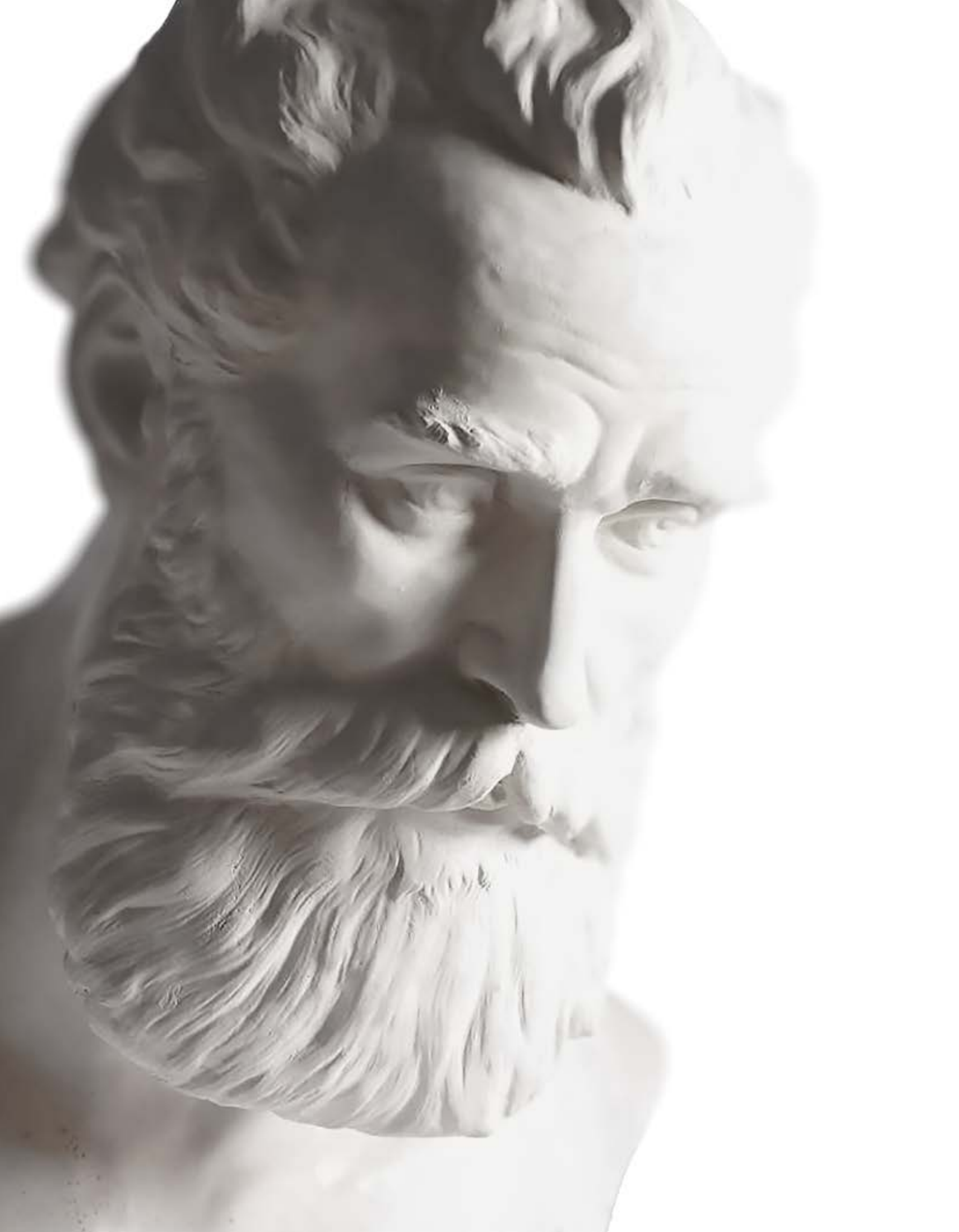

[en] Michael Thonet (1796-1871) and his five children were the most successful manufacturers of furniture in the Industrial Age. Having been invited to develop a patent in Austria by Chancellor Metternich, who had seen his products at the Exhibition held by the society of friends of arts in Koblenz, in 1842, Michael Thonet left Boppard in Germany, to settle in Vienna, where in 1853 he founded the company "Gebrüder Thonet" by involving his five sons. In the Hapsburg capital, Michael Thonet abandoned the more traditional technique of glued lamellar wood in favour of the industrial chemical - mechanical steam bent process. This innovation led him to begin producing wooden furniture, presenting a collection of elegant, yet practical designs that could be manufactured on a larger scale. He immediately supported this with a distribution and sales network that was capable of penetrating any market. It was during this time that products such as chair No. 1 designed for the famous Viennese Palais Schwarzenberg made their début, gaining fame as 'typically' Thonet, and from which many other models were then designed, up to and including the classic chair No. 14. The company's use of high technology and production techniques, together with widespread fame and a

[de] Michael Thonet (1796-1871) und seine fünf Söhne waren die erfolgreichsten Möbelhersteller des Industriezeitalters. Auf Einladung des österreichischen Kanzlers Metternich, der seine Produkte auf der Ausstellung des Vereins der Kunstfreunde Koblenz gesehen hatte und ihm vorschlug, sein Patent in Österreich zu entwickeln, verließ Michael Thonet im Jahre 1842 das in Deutschland gelegene Boppard, um sich in Wien niederzulassen. 1853 gründete er gemeinsam mit seinen fünf Söhnen das Unternehmen „Gebrüder Thonet“. In der Hauptstadt des habsburgischen Reiches ging Michael Thonet von der Technik des geleimten Lamellenholzes zu der des unter Dampf gebogenen Rundholzes über, d.h. zu einem chemisch-mechanischen Verfahren industrieller Natur. Dank dieser Innovation begann er, Holzmöbel herzustellen, indem er eine Kollektion mit vier gleichermaßen eleganten und rationalen Formen schuf. Zugleich erlaubte ihm das dabei angewandte Verfahren die Herstellung großer Mengen. Dazu gesellte sich sofort ein Vertriebs- und Verkaufssystem, das in der Lage war, in jeden beliebigen Markt vorzudringen. In jener Zeit entstanden Produkte wie der Stuhl „Nr. 1“, der für das berühmte Palais Schwarzenberg in Wien entworfen wurde. Er gilt als der „typische“ Thonetstuhl, von dem später die unzähligen Modelle bis hin zum Stuhl „Nr. 14“ abgeleitet wurden. Der Einsatz modernster Technologien und Herstellungsverfahren, die Verbreitung



HENRI DE TOULOUSE-LAUTREC. FASHIONABLE PEOPLE AT LES AMBASSADEURS (AUX AMBASSADEURS: GENS CHIC).
Dated: 1893. Dimensions: overall: 84.3 x 65.5 cm (33 3/16 x 25 13/16 in.). Oil l'essence over black chalk on wove paper, mounted on cardboard.
Washington DC, National Gallery of Art. © 2018. Album/Scala, Firenze

growing reputation, encouraged the most important Viennese architects to design new products. Otto Wagner commissioned the furnishing of the Post Sparkasse. Adolf Loos designed the chair for the Café Museum, in 1895 writing: "When I was in America, I realised that the Thonet chair was the most modern seating available". In 1911, the Gebrüder Thonet catalogue boasted 980 different models. By the end of the second world war, independent production plants had been set up in various different countries and developed into separate businesses.

In Austria, the home market of Gebrüder Thonet, the business was rebuilt by descendants of Michael Thonet, including his great-grandson Fritz Jakob Thonet as well as Fritz Jakob's children Evamarie Thonet and Richard Thonet. After the war, they had to start from scratch, with little more than their experience and

der Produkte und die zunehmende Bekanntheit des Unternehmens veranlassen die bedeutendsten Wiener Architekten dazu, neue Produkte zu entwerfen. Otto Wagner ließ die Einrichtung für die Postsparkasse herstellen. Adolf Loos entwarf den Stuhl für das Café Museum und schrieb 1895: „Als ich in Amerika war, begriff ich, dass der Thonetstuhl der modernste Stuhl ist, den es gibt.“ Im Jahre 1911 zählte der Katalog der Gebrüder Thonet 980 verschiedene Modelle. Am Ende des Zweiten Weltkriegs entstanden in verschiedenen Ländern unabhängige Produktionseinheiten, die sich in getrennte Unternehmen entwickelten. In Österreich, dem Heimatmarkt von Gebrüder Thonet, wurde das Geschäft von Michael Thonets Nachfahren wieder aufgebaut, darunter sein Urgroßenkel Fritz Jakob Thonet sowie dessen Kindern Evamarie Thonet und Richard Thonet. Nach dem Krieg mussten sie ganz von vorn anfangen, mit kaum mehr als ihrer Erfahrung und Leidenschaft für Möbel.

passion for furniture. They recommenced their business in one of Gebrüder Thonet's former warehouses in Vienna. From 1948 on they rented a production site in Rohrau, Steiermark, before they finally built their own production site in Friedberg in 1962. In 1976 the Austrian business changed its name from Gebrüder Thonet to its current name Gebrüder Thonet Vienna. More recently, Gebrüder Thonet Vienna GmbH (GTV) has developed its work in a successful blend of the traditional and the modern, of continuity and renewal, with a new production program that begins by re-editing a series of Gebrüder Thonet classics. At the same time, GTV stands for contemporary furnishing. Advanced production techniques are applied to innovative designs and uses of materials, to create highly

Unmittelbar nach dem Krieg nahmen sie in einem ehemaligen Wiener Warenlager von Gebrüder Thonet die Geschäftstätigkeit wieder auf. Von 1948 an pachteten sie eine Fabrik in Rohrau, Steiermark, bevor sie 1962 schließlich ihre eigene Fabrik in Friedberg eröffneten. 1976 änderten sie den Namen von Gebrüder Thonet in den heutigen Namen Gebrüder Thonet Vienna. In jüngster Zeit entwickelte Gebrüder Thonet Vienna GmbH (GTV) ihre Tätigkeit zwischen Tradition und Innovation, Kontinuität und Erneuerung und rief ein gegliedertes Produktionsprogramm ins Leben, das sich in erster Linie zum Ziel setzt, eine Reihe historischer, von Gebrüder Thonet geschaffener Gegenstände in Form einer Neuausgabe anzubieten. Zugleich repräsentiert GTV die Vorstellung von zeitgenössischer Einrichtung. Durch den Einsatz fortschrittlicher Produktionstechniken werden Design und Materialverwendung



Claudia Cardinale and Alberto Sordi in "A girl in Australia" (Ronald Grant Archive / Mary Evans)



DEGAS, EDGAR (1834-1917): MADAME ALEXIS ROUART ET SES ENFANTS.
1905. Parigi, Musee du Petit Palais. peinture, cm. 160 x 141 © 2018. Photo Josse/Scala, Firenze



Winston Churchill (CPT TANNER - No 2 Army Film and /AFP/Getty Images)

"Form ever follows function."

(Louis Sullivan)

sought-after, multipurpose furnishing items. Truly original, up-to-date solutions that integrate well with the more classic products of its catalogue, now reworked. Items such as chair No. 14, of which more than 50 million were made between 1850 and 1930, have gone down in history for their fine design and manufacturing quality, and yet still today excite and attract new generations. GTV always succeeds in finding the perfect combination of tradition and innovation, assisted by continuous research into new, clear-cut, versatile designs. GTV is open and looking to the future, without, however, leaving the values and experience of the past behind. This collection is a true reflection of the evolution of our times.

weiterentwickelt, um sehr begehrte, vielfältig einsetzbare Einrichtungsgegenstände zu schaffen. Es handelt sich um innovative und zeitgemäße Lösungen, die sich nahtlos in die klassischen Stücke des Produktkatalogs einreihen. Die aufgrund von Form und Verarbeitungsqualität in die Geschichte eingegangenen Stücke, wie der Stuhl Nr. 14, der zwischen 1850 und 1930 mehr als 50 Millionen mal hergestellt wurde, können noch heute Emotionen hervorrufen und neue Generationen faszinieren. GTV gelingt es, Tradition und Innovation perfekt miteinander zu kombinieren und dabei stets nach neuen, klaren und vielseitigen Formen zu streben. GTV ist offen und zukunftsgerichtet, ohne dabei die Werte und Erfahrungen aus der Vergangenheit aufzugeben. Diese Kollektion spiegelt die Evolution unserer Zeit wider.



Rita Hayworth and Gene Kelly (Ned Scott/John Kobal Foundation/Getty Images)



Le Corbusier (Wolfgang Kuhn/United Archives via Getty Images)



Toulouse-Lautrec, Henri de (1864-1901): *At the Moulin Rouge*, digitale (1) 1892/95. Oil on canvas, 123 x 141 cm. Helen - Birch Bartlett Memorial Collection, 1928.610. Chicago (IL), Art Institute of Chicago. © 2018. The Art Institute of Chicago / Art - Resource, NV/ Scala, Firenze

[it] Michael Thonet (1796-1871) e i suoi cinque figli furono i produttori di mobili di maggior successo dell'era industriale. Invitato dal cancelliere austriaco Metternich, che aveva visto i suoi prodotti all'Esposizione della Società degli Amici delle Arti di Coblenza, a sviluppare il proprio brevetto in Austria, nel 1842 Michael Thonet lasciò Boppard, in Germania, per stabilirsi a Vienna, dove nel 1853 fondò l'azienda "Gebrüder Thonet" coinvolgendo i suoi cinque figli. Nella capitale dell'impero asburgico, Michael Thonet passò dalla tecnica del legno lamellare incollato a quella del tondino incurvato a vapore, cioè a un processo chimico e meccanico di tipo industriale. Grazie a questa innovazione iniziò a produrre mobili in legno proponendo una collezione di forme eleganti e insieme razionali, con un procedimento che consentiva la produzione in grande serie. A questo si aggiunse subito, un sistema di distribuzione e di vendita in grado di penetrare qualsiasi mercato. In quel periodo nacquero prodotti come la sedia "N.1" progettata per il famoso palazzo Schwarzenberg di Vienna, considerata la sedia "tipo" Thonet, da cui derivarono poi innumerevoli modelli fino alla sedia "N.14". Conoscenze tecnologiche e produttive di alto livello, diffusione dei prodotti e notorietà dell'azienda spinsero i più importanti architetti

[fr] Michael Thonet (1796-1871) et ses cinq fils ont été les producteurs de meubles ayant obtenu le plus grand succès de l'ère industrielle. Invité par le chancelier autrichien Metternich, qui avait vu ses produits à l'Exposition de la Société des Amis des Arts de Coblenze, à développer son brevet en Autriche, en 1842 Michael Thonet laisse Boppard en Allemagne pour s'établir à Vienne, où en 1853 il fonde la société «Gebrüder Thonet» en impliquant ses cinq fils. Dans la capitale de l'empire habsbourgeois, Michael Thonet passe de la technique du bois lamellé collé à celle du bois de section ronde courbé à la vapeur, c'est-à-dire à un processus chimique et mécanique de type industriel. Grâce à cette innovation, il commence à produire des meubles en bois en proposant une collection de formes à la fois élégantes et rationnelles, avec une technique qui permet de produire en grande quantité. À cela s'ajoute très rapidement un système de distribution et de vente en mesure de pénétrer tout type de marché. Au cours de cette période, naissent des produits tels que la chaise "N. 1" conçue pour le célèbre Palais Schwarzenberg de Vienne, considérée comme étant la chaise "type" Thonet, d'où dérivent par la suite de nombreux modèles jusqu'à la chaise "N. 14". Des connaissances technologiques et de production de haut niveau, la diffusion des modèles et la notoriété de l'entreprise poussent les plus grands architectes viennois à réaliser de nouveaux produits.



viennesi a progettare nuovi prodotti. Otto Wagner fece realizzare gli arredi per la Postsparkasse, Adolf Loos disegnò la sedia per il Café Museum e scrisse nel 1895: "Quando ero in America compresi che la sedia Thonet è la sedia più moderna che ci sia". Nel 1911 il catalogo Gebrüder Thonet contava 980 modelli diversi. Al termine della seconda guerra mondiale nacquero unità di produzione indipendenti in varie nazioni che svilupparono imprese differenti. In Austria, patria di Gebrüder Thonet, l'attività fu ricostituita da alcuni discendenti di Michael Thonet, compreso il suo bisnipote Fritz Jakob Thonet e i suoi figli Evamarie Thonet e Richard Thonet. Dopo la guerra, dovettero ricominciare dal nulla, con poco più che passione e conoscenza per i mobili. L'attività riprese a Vienna presso uno dei vecchi magazzini di Gebrüder Thonet. A partire dal 1948 Frizjacob, Richard e Evamarie affittarono uno stabilimento a Rohrau, Steiermark, prima di realizzare il loro sito produttivo a Friedberg in 1962. Nel 1976 la società cambiò nome in Gebrüder Thonet Vienna. Recentemente Gebrüder Thonet Vienna GmbH (GTV) ha sviluppato la propria attività fra tradizione e innovazione, continuità e rinnovamento, dando vita ad un programma di produzione articolato, che si propone in primo luogo di recuperare in

Otto Wagner fait réaliser les décorations pour la Postsparkasse, Adolf Loos dessine la chaise pour le Café Museum et en 1895 il écrit: "Lorsque j'étais en Amérique, j'ai compris que la chaise Thonet est la chaise la plus moderne qui soit". En 1911, le catalogue Gebrüder Thonet compte 980 modèles différents. À la fin de la seconde guerre mondiale, des unités de production indépendantes, qui ont développé différentes entreprises, naissent dans différents pays. En Autriche, la patrie de Gebrüder Thonet, l'activité a été reconstitué par certains descendants de Michael Thonet, dont son arrière-petit-fils Fritz Jakob Thonet et ses fils Evamarie Thonet et Richard Thonet. Après la guerre, ils ont dû repartir de zéro, avec un peu plus que la passion et les connaissances pour le mobilier. Les activités ont repris à Vienne à l'un des anciens entrepôts de Gebrüder Thonet. Depuis 1948 Frizjacob, Richard et Evamarie loué une usine à Rohrau, Steiermark, avant de faire leur site de production à Friedberg en 1962. En 1976 le nom de la société a changé en Gebrüder Thonet Vienna. Récemment, Gebrüder Thonet Vienna GmbH (GTV) a relancé sa vocation pour l'ameublement de caractère, en développant son activité entre tradition et innovation, continuité et renouvellement, en faisant naître un programme de production articulé qui se propose, en premier lieu, de récupérer sous forme de rééditions, une série

forma di riedizioni una serie di oggetti storici creati dalla Gebrüder Thonet. Il nome GTV rappresenta l'idea stessa dell'arredamento contemporaneo. Molteplicità delle funzioni d'uso, utilizzo di tecniche produttive avanzate e funzionali alla realizzazione di prodotti unici, innovazione nelle forme e nell'uso dei materiali, uniti ad un design ricercato, sono il fil rouge dei nuovi progetti della GTV, capace di proporre soluzioni innovative attuali ben integrate e coerenti con le riedizioni più classiche del suo catalogo. Pezzi mitici per forma e per qualità di lavorazione, come la sedia N.14, prodotta in oltre 50 milioni di esemplari tra il 1850 e il 1930, riescono ancora oggi ad emozionare ed attrarre nuove generazioni. GTV è in grado di coniugare sempre tradizione e innovazione, ricerca continua di nuove forme e d'alto contenuto di design, sobrietà e versatilità d'uso. GTV è dunque un'azienda aperta al futuro, che trae dal passato i valori e le esperienze per esprimere una collezione che riflette l'evoluzione del nostro tempo.

d'objets historiques créés par Gebrüder Thonet. Le nom de GTV représente l'idée même de l'ameublement contemporain. La multiplicité des fonctions d'utilisation, l'emploi de techniques de production avancées et fonctionnelles jusqu'à la réalisation de produits uniques, l'innovation dans les formes et dans les matériaux, ainsi qu'un design recherché, représentent le fil rouge des nouveaux projets de GTV, capable de proposer des solutions innovantes, actuelles, bien intégrées et cohérentes avec les rééditions les plus classiques de son catalogue historique. Des pièces mythiques pour la forme et pour la qualité d'élaboration, comme la chaise "N. 14", produite en plus de 50 millions d'exemplaires entre 1850 et 1930, réussissent encore aujourd'hui à émouvoir et à attirer de nouvelles générations. GTV est toujours en mesure de conjuguer tradition et innovation, recherche constante de nouvelles formes et haut contenu en design, sobriété et flexibilité d'utilisation. GTV est donc une entreprise ouverte vers le futur, qui tire du passé les valeurs et les expériences pour exprimer une collection reflétant l'évolution de notre époque.



Actress Anita Ekberg Posing on Chair (Corbis Historical/Getty Images)

“I had three chairs
in my house;
one for solitude,
two for friendship,
three for society.”

(Henry David Thoreau)



[en] The intrinsic importance, material and not material, of GTV collection is expressed by the brand Wiener GTV Design, engraved on a coin embedded in the structure of each individual piece: a precious detail that attests to the authenticity, in stable equilibrium between industry and craftsmanship.

[de] Der materielle und immaterielle innere Wert der Kollektionen von GTV wird durch die Marke Wiener GTV Design ausgedrückt, die auf gravierten Münzen in jedes einzelne Stück eingebettet wird: ein wertvolles Detail, das die Echtheit in einem stabilen Gleichgewicht zwischen Industrie und hoher Handwerkskunst bestätigt.

HERITAGE



[it] L'intrinseco valore, materiale e immateriale, della collezione GTV è espresso nel marchio Wiener GTV Design, inciso su una moneta incastonata nella struttura di ogni singolo pezzo: un dettaglio prezioso che ne attesta l'autenticità, in equilibrio stabile fra industria ed alto artigianato.

[fr] La valeur intrinsèque, matérielle et immatérielle, de la collection GTV est exprimée dans la marque Wiener GTV Design, gravée sur une monnaie enchâssée dans la structure de chaque pièce: un détail précieux qui en atteste l'authenticité, en équilibre stable entre l'industrie et l'artisanat de haut niveau.

[en] Year after year, GTV has become increasingly sensitive to environmental issues and with a view to achieving continuous improvement, it complies with the regulations that privilege the use of sustainable processes and materials. A clear sign, an incisive foothold, which marks a path that looks keenly towards the continuity, also ethical, between the production cycle and the product. A major commitment taken by the company to offer concrete guarantees in terms of environmental friendliness and care for the consumer's health, with the aim of establishing a trust-based relationship through an approach integrated within sustainable development.

To manufacture its collections, Gebrüder Thonet Vienna GmbH chooses to use wood certified by the FSC®, Forest Stewardship Council®, the main

international certification system that ensures that wood is sourced from forests where stringent environmental, social and economic standards are observed. There are also other types of processing on Gebrüder Thonet Vienna products, which are less visible yet just as important - for greater sustainability. Indeed, the company has begun to convert its painting process, moving away from polyurethane-based paints towards the use of water-based paints, both to cut down atmospheric emissions, as well as for greater protection of the staff in charge of this particular process. In 2021 GTV has inaugurated a new Green project, introducing products that are entirely sustainable, including the new Beaulieu chair, designed by Philippe Nigro. For these FSC certified products coated with water-based paint, the company is

offering a polyurethane padding produced with the innovative Variable Pressure Foaming (VPF) technology which makes it possible not to use foaming agents that are harmful for the environment, obtaining a material that is foamed solely with water, totally eco-compatible and recyclable. For the upholstery cover, the company uses a selection of fabrics made from plastic or natural recycled fibres. Moreover, GTV uses recycled and sustainable materials for the chair's support feet too, and these can easily be replaced simply with a click-in system. From the finished product to its packaging for dispatch, in FSC certified cardboard, all the internal components are also made of recyclable material and separate, in order to be disposed of in full.



[it] Anno dopo anno GTV è sempre più sensibile alle problematiche ambientali e in un'ottica di miglioramento continuo e aderisce alle normative che privilegiano l'uso di processi e materiali sostenibili. Un segno netto, una presa di posizione incisiva che traccia un percorso volto a dare continuità, anche etica, tra ciclo produttivo e prodotto. Un forte impegno assunto dall'azienda per offrire garanzie concrete in termini di rispetto per l'ambiente e salute della clientela, con l'obiettivo di instaurare un rapporto di fiducia duraturo, grazie ad un approccio integrato allo sviluppo sostenibile. Per la produzione delle sue collezioni, Gebrüder Thonet Vienna GmbH sceglie di utilizzare legno certificato FSC®, Forest Stewardship Council®, il principale sistema di certificazione internazionale

che garantisce che il legno provenga da foreste dove sono rispettati rigorosi standard ambientali, sociali ed economici. Ci sono inoltre altre lavorazioni sui prodotti Gebrüder Thonet Vienna, meno visibili ma altrettanto importanti, per una maggiore sostenibilità. L'azienda ha infatti iniziato una conversione del processo di verniciatura, abbandonando le vernici poliuretaniche per passare ad un'utilizzo di vernici all'acqua, sia per abbattere le emissioni in atmosfera, sia per una maggiore tutela del personale addetto a questa lavorazione. Nel 2021 GTV inaugura un nuovo progetto Green, realizzando alcuni modelli interamente sostenibili, tra cui la nuova sedia Beaulieu, firmata da Philippe Nigro. Per questi prodotti, certificati FSC e verniciati all'acqua, l'azienda propone per l'imbottitura un

poliuretano prodotto con l'innovativa tecnologia Variable Pressure Foaming (VPF) che permette di non impiegare agenti espandenti dannosi per l'ambiente, ottenendo un materiale espanso con sola acqua, totalmente eco-compatibile e riciclabile. Per il rivestimento l'azienda offre una selezione di tessuti costituiti da fibre plastiche o naturali riciclate. Inoltre, GTV utilizza materiali sostenibili anche per i piedini di appoggio della sedia, sostituibili con un semplice sistema a scatto. Dal prodotto fino al suo imballaggio per la spedizione, in cartone certificato FSC, anche tutti i suoi componenti interni sono in materiale riciclabile e separati, così da poter essere interamente smaltiti.

[de] Von Jahr zu Jahr beschäftigt sich GTV immer intensiver mit den Themen Umwelt und Nachhaltigkeit. GTV arbeitet an der ständigen Verbesserung der bereits eingesetzten nachhaltigen Prozesse sowie dem Einsatz von nachhaltigen Materialien. Ein klares Zeichen, mit dem deutlich Stellung bezogen und ein Weg verfolgt wird, in dessen Fokus die - auch ethische - Nachhaltigkeit zwischen dem Fertigungsprozess und dem Produkt liegt. Im Rahmen des integrierten Ansatzes von Nachhaltigkeit bedeutet dies auch, eine langfristige Vertrauensbeziehung zu unseren Kunden und Partnern aufzubauen, unterstützt durch Garantiezertifikate bezüglich Umweltschutz und Gesundheit. Für die Produktion seiner Kollektionen entscheidet sich Gebrüder Thonet Vienna GmbH für Holz mit der FSC®-Zertifizierung, des Forest Stewardship Council®, das wichtigste Internationale

Zertifizierungssystem, das sicherstellt, dass das Holz aus Wäldern stammt, in denen strenge ökologische, soziale und wirtschaftliche Umweltauflagen befolgt werden. Die Produkte von Gebrüder Thonet Vienna werden im Sinne von verbesserter Nachhaltigkeit außerdem weiteren, weniger sichtbaren, jedoch ebenso wichtigen Adaptierungen unterzogen. Unter anderem verwendet GTV statt Polyurethanlacken ausschließlich wasserbasierte Lacke, die besonders umweltfreundlich sind und auch zum Schutz der für diesen Arbeitsprozess zuständigen Mitarbeiter beitragen. 2021 startete GTV ein neues Nachhaltigkeitsprojekt: Erstmals werden einige vollkommen nachhaltig produzierte Modelle präsentiert, wie zB der neue Stuhl Beaulieu, der die Handschrift von Philippe Nigro trägt. Für diese FSC-zertifizierten und wasserlackierten Produkte bietet das Unternehmen

Polsterungen an, die mit der innovativen Variable Pressure Foaming-Technologie (VPF) ausgestattet sind. Dabei handelt es sich um einen umweltfreundlichen und recyclebaren Polyurethanschäumstoff, der vollständig auf den Einsatz von umweltschädlichen Treibmitteln verzichtet und ausschließlich mit Wasser geschäumt wird. Hinsichtlich Bezugsmaterialien bietet das Unternehmen eine Auswahl von Stoffen an, die aus recycelten Kunststoff- oder Naturfasern bestehen. Außerdem verwendet GTV recycelte und nachhaltige Materialien auch für die FüÙe des Stuhls, die mit einem einfachen Einschnappsystem gewechselt werden können. Vom Produkt bis zur Transportverpackung aus FSC-zertifiziertem Karton sind auch alle seine inneren Bestandteile aus recyclebarem Material, sodass sie zur Gänze entsorgt werden können.



[fr] Année après année, GTV est de plus en plus sensible aux questions environnementales et, dans un souci d'amélioration continue, adhère aux réglementations qui favorisent l'utilisation de processus et de matériaux durables. Un signe clair, une prise de position incisive qui trace un chemin visant à donner une continuité, y compris éthique, entre le cycle de production et le produit. Un engagement fort pris par l'entreprise pour offrir des garanties concrètes en matière de respect de l'environnement et de la santé de ses clients, dans le but d'établir une relation de confiance qui dure à travers une approche intégrée du développement durable. Pour la production de ses collections, Gebrüder Thonet Vienna GmbH choisit d'utiliser du bois certifié FSC®, Forest Stewardship Council®, le principal

système de certification international qui garantit que le bois provient de forêts où des normes environnementales, sociales et économiques strictes sont respectées. Il existe également d'autres processus moins visibles, mais tout aussi importants, sur les produits de Gebrüder Thonet Vienna pour une plus grande durabilité. En effet, l'entreprise a commencé à convertir son processus de peinture, en abandonnant les peintures polyuréthanes et en passant à l'utilisation de peintures à base d'eau, tant pour réduire les émissions atmosphériques que pour une plus grande protection du personnel impliqué dans ce processus. En 2021, GTV inaugure un nouveau projet Green, en produisant quelques modèles entièrement durables, dont la nouvelle chaise Beaulieu, conçue par Philippe Nigro. Pour ces produits vernis à l'eau et certifiés FSC,

l'entreprise propose pour le rembourrage un polyuréthane produit avec l'innovante technologie VPF (Variable Pressure Foaming), qui permet de ne pas utiliser d'agents expansifs nocifs pour l'environnement, en obtenant un matériau expansé uniquement à l'eau, totalement éco-compatible et recyclable. Pour le rembourrage, l'entreprise propose une sélection de tissus fabriqués à partir de plastique recyclé ou de fibres naturelles. GTV utilise également des matériaux recyclés et durables pour les patins de la chaise, qui peuvent être remplacés par un simple système de clip-sage. Du produit à son emballage pour l'expédition, en carton certifié FSC, tous ses composants internes sont eux aussi constitués de matériaux recyclables et séparés afin de pouvoir être éliminés entièrement.

[en] In Friedberg, Styria (Austria), the „Thonet“ museum, owned by GTV, is a benchmark for its history, where testimonies, curiosities and the most representative original parts of the company find the place to be. A fascinating reality that through these icons of style tells the company's deep passion for the solid bent wood.

[de] In Friedberg in der Steiermark (Österreich) stellt das Museum „Thonet“, im Besitz von GTV, einen Referenzpunkt für die Geschichte der Marke dar, wo sich Zeugnisse, Kuriositäten und die für die Produktion der Firma repräsentativsten Originalstücke befinden. Eine faszinierende Realität, in der durch diese Stilikonen die große Leidenschaft des Unternehmens für solide Buchholzmöbel erzählt wird.



[it] A Friedberg, nella Stiria (Austria), il museo „Thonet“ di proprietà di GTV, si pone come punto di riferimento per la storia della società, dove trovano la giusta collocazione le testimonianze, le curiosità e i pezzi originali più rappresentativi dell'azienda. Una realtà affascinante che attraverso queste icone di stile racconta la profonda passione aziendale per il legno massello curvato.

[fr] À Friedberg, en Styrie (Austrie), le musée «Thonet» est un point de référence pour l'histoire de la société, racontée au travers des témoignages, curiosités et pièces originales les plus représentatifs de la compagnie. Une fascinant réalité qui, grâce à ces icônes de style, raconte la passion profonde de la société pour le bois massif courbé.

PRODUCTS





BEAULIEU
DESIGN PHILIPPE NIGRO, 2021













BISTROTSTUHL
DESIGN NIGEL COATES, 2016





BODYSTUHL
DESIGN NIGEL COATES, 2015









BREZEL
DESIGN LUCIDIPEVERE, 2014





CAFÉSTUHL

DESIGN NIGEL COATES, 2016





CZECH

DESIGN HERMANN CZECH, 1994

















GUSTAV

DESIGN GORDON GUILLAUMIER, 2014





LOOS CAFÉ MUSEUM

DESIGN ADOLF LOOS, 1898





MAGISTRETTI
DESIGN VICO MAGISTRETTI, 2003





MALIT

DESIGN GEBRÜDER THONET VIENNA GMBH (GTV), 2017





MORRIS
DESIGN GAMFRATESI, 2015





N. O
DESIGN FRONT, 2017









N. 1
DESIGN MICHAEL THONET, 1850





N. 14

DESIGN MICHAEL THONET, 1860





N. 18

DESIGN GEBRÜDER THONET, 1876





N. 811

DESIGN JOSEF HOFFMANN, 1930









PINCE
DESIGN LUCIDIPEVERE, 2017





POST MUNDUS
DESIGN MARTINO GAMPER, 2012





POSTSPARKASSE
DESIGN OTTO WAGNER, 1906









RADETZKY

DESIGN MICHELE DE LUCCHI, 2015

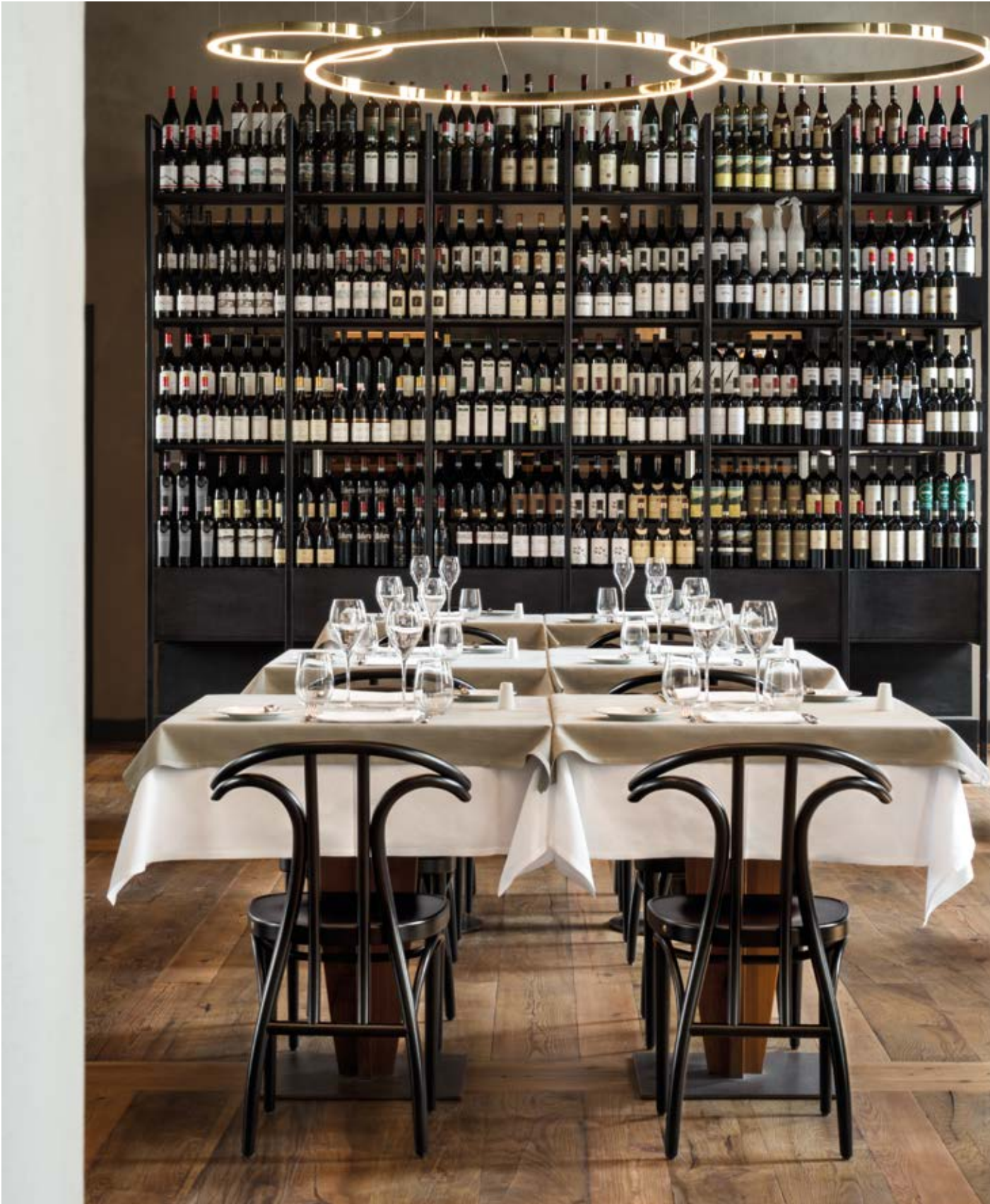







SÖLDEN

DESIGN GEBRÜDER THONET VIENNA GMBH (GTV), 2020













SUGILOO

DESIGN MICHAEL ANASTASSIADES, 2020













**“Chairs are architecture,
sofas are bourgeois.”**

(Le Corbusier)

VIENNA 144

DESIGN GEBRÜDER THONET, 1908





WIENER STUHL
DESIGN GEBRÜDER THONET, 1904









CIRQUE
DESIGN MARTINO GAMPER, 2015







RUHERING

DESIGN FRANCO MELLO AND LEANDRO AGOSTINI, 2016



COAT RACK BENCH

DESIGN FRONT, 2014









SINGLE CURVE

DESIGN NENDO, 2015













TRIO

DESIGN MARTINO GAMPER, 2015





VIENNA 144 HOCKER AND BARHOCKER

DESIGN GEBRÜDER THONET, 1908





CHIGNON

DESIGN LUCIDIPEVERE, 2017









HIDEOUT

DESIGN FRONT, 2015









HOLD ON
DESIGN NICOLA GALLIZIA, 2014





JANNIS
DESIGN DAINELLI STUDIO, 2020

















LEHNSTUHL
DESIGN NIGEL COATES, 2014









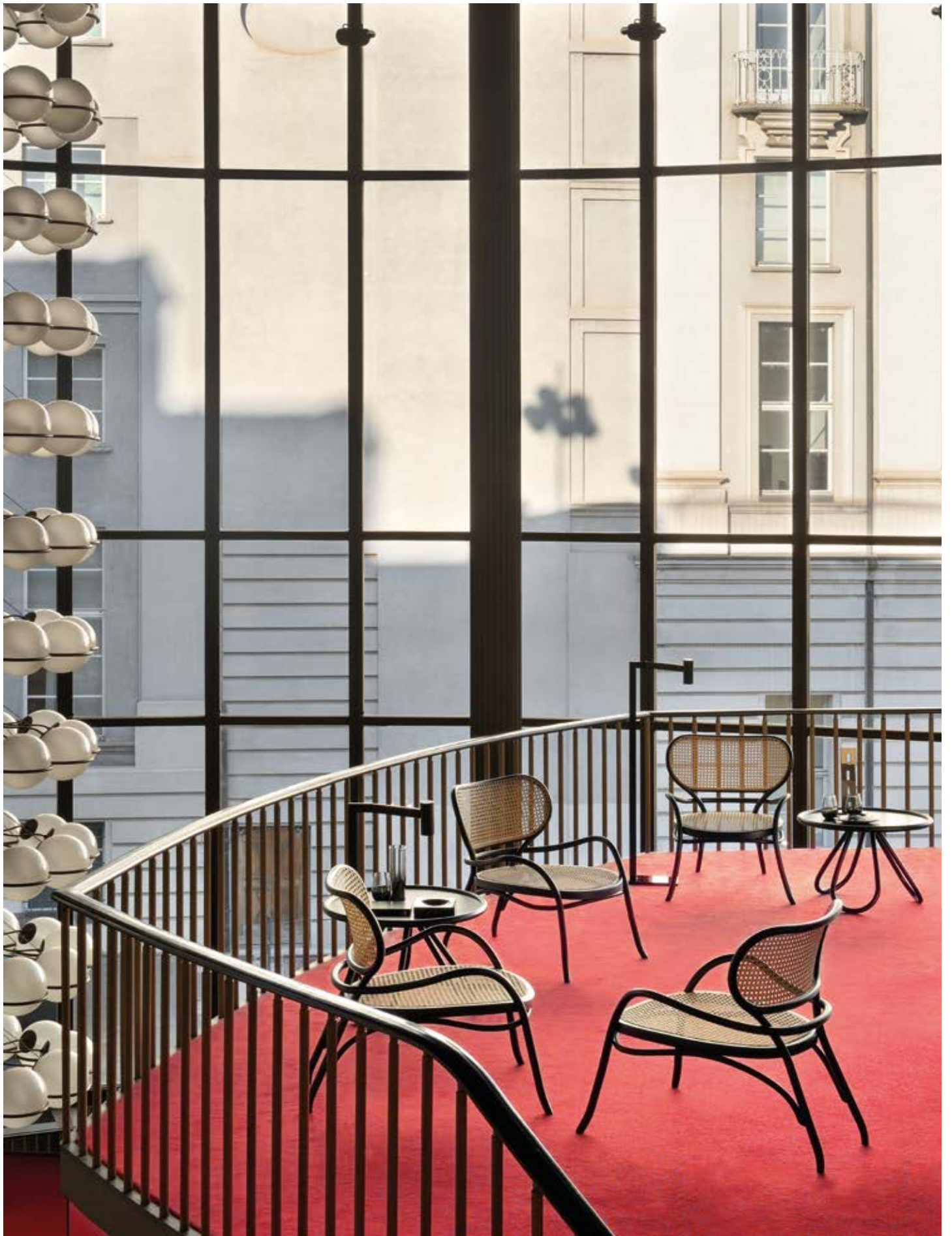



**“Why bother choosing
a certain chair?
Because that chair says
something about you.”**

(David Bowie)

LOÏE
DESIGN CHIARA ANDREATTI, 2018









N. 200

DESIGN MICHAEL ANASTASSIADES, 2019









PROMENADE
DESIGN PHILIPPE NIGRO, 2017









SCHAUKELSTUHL

DESIGN GEBRÜDER THONET, 1885





SUZENNE
DESIGN CHIARA ANDREATTI, 2019













TARGA
DESIGN GAMFRATESI, 2015













MOS
DESIGN GAMFRATESI, 2019



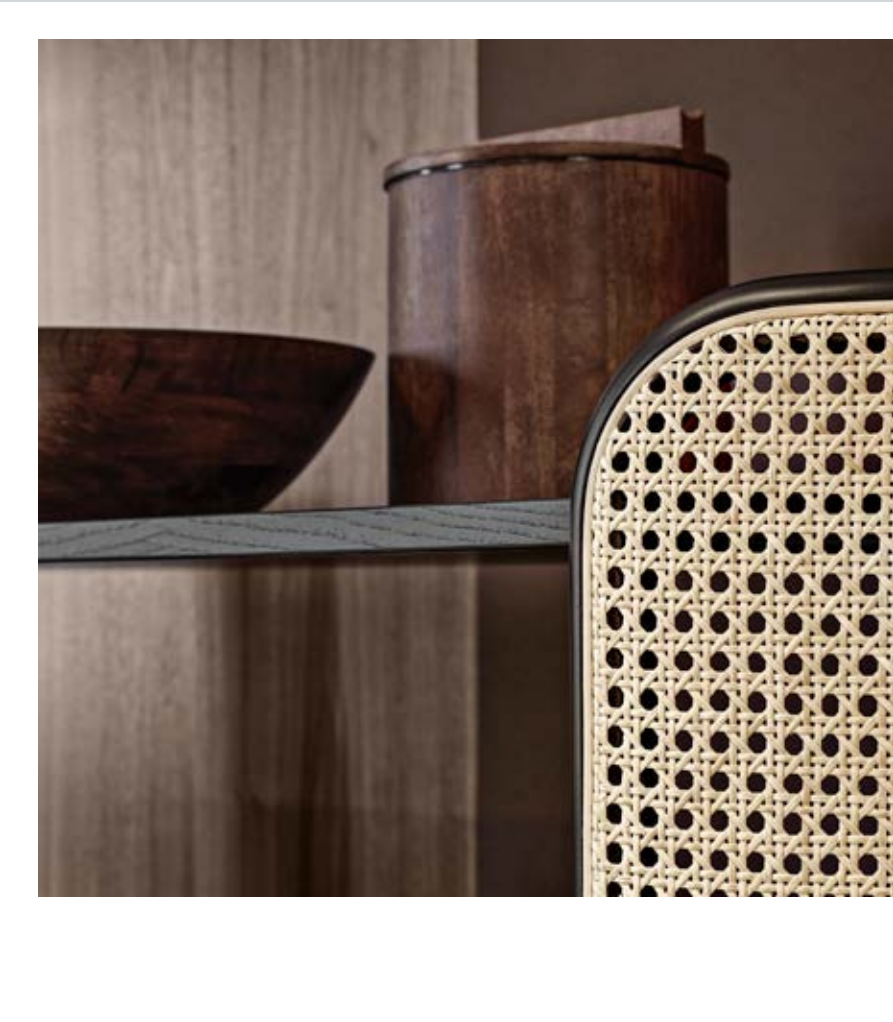













NYNY
DESIGN STORAGE MILANO, 2020













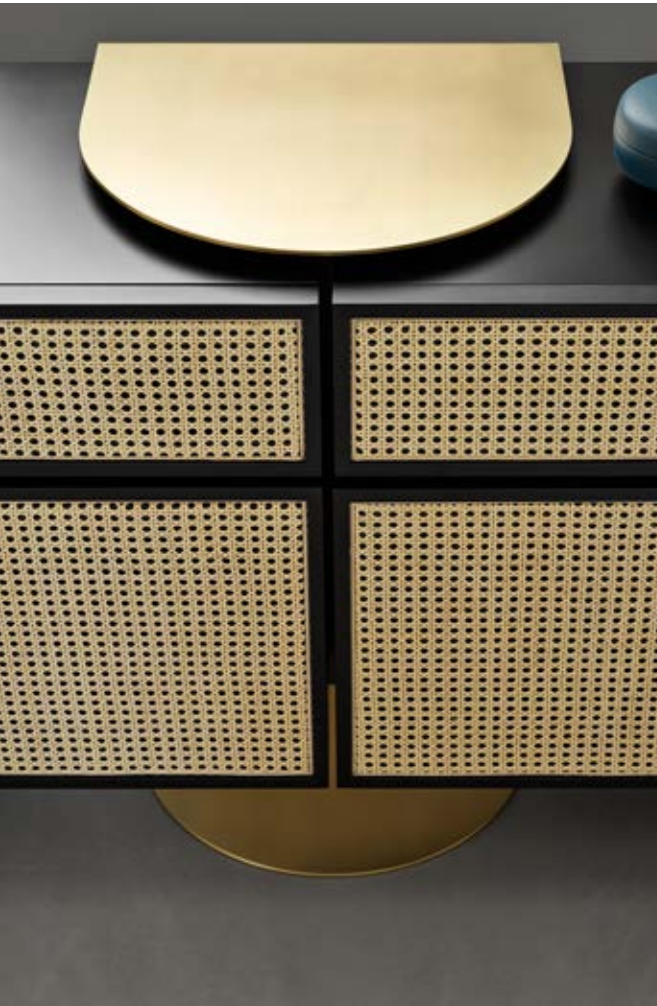







OTTOW
DESIGN STORAGE MILANO, 2019









RUE
DESIGN GAMFRATESI, 2019









YVETTE
DESIGN CHIARA ANDREATTI, 2019





ARCH DINING TABLE

DESIGN FRONT, 2014





CARYLLON
DESIGN CRISTINA CELESTINO, 2018





















REHBEINTISCH
DESIGN GEBRÜDER THONET, 1888









RING DINING TABLE

DESIGN GEBRÜDER THONET VIENNA GMBH (GTV), 2015





SÄULE
DESIGN FABIO FANTOLINO, 2021







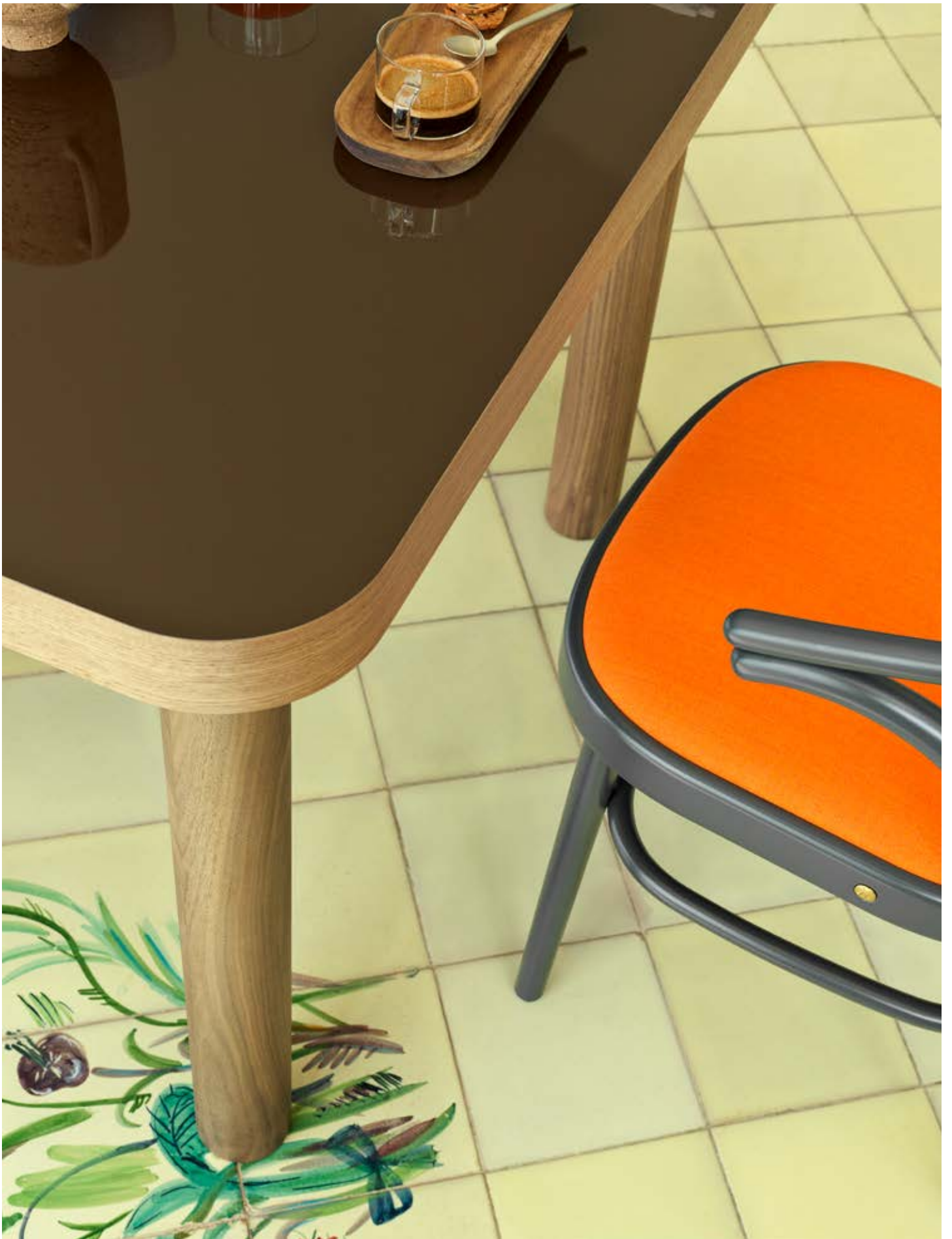





COGNAC

DESIGN GEBRÜDER THONET VIENNA GMBH (GTV), 2018



PASTIS

DESIGN GEBRÜDER THONET VIENNA GMBH (GTV), 2014



PORTO

DESIGN GEBRÜDER THONET VIENNA GMBH (GTV), 2014



RUM

DESIGN GEBRÜDER THONET VIENNA GMBH (GTV), 2020



SHERRY

DESIGN GEBRÜDER THONET VIENNA GMBH (GTV), 2018





**“Hey buddy, don’t you
be no square, if you
can’t find a partner
use a wooden chair.”**

(Elvis Presley)

VERMOUTH

DESIGN GEBRÜDER THONET VIENNA GMBH (GTV), 2014





ARCH COFFEE TABLE
DESIGN FRONT, 2014





DUET

DESIGN CRISTIAN MOHADED, 2017





PEERS
DESIGN FRONT, 2020









WIENER BOX

DESIGN CRISTIAN MOHADED, 2018









ALLEGORY DESK

DESIGN GAMFRATESI, 2015





CLOUD

DESIGN GEBRÜDER THONET, 1890



EYESHINE MIRRORS

DESIGN ANKI GNEIB, 2015



FENG

DESIGN TESTATONDA, 2021









FURIA
DESIGN FRONT, 2016





KLEIDERSTÄNDER
DESIGN GEBRÜDER THONET, 1905



KLEIDERSTÄNDER P29

DESIGN GEBRÜDER THONET, 1929

Two days, the first solo exhibition in Italy of works by Calvin Cordwell, will include installations, artworks, films and video created between 2010 and 2014. The exhibition presents her key works together with a new one specially created for Pirelli HangarBicocca, which will involve an unprecedented collaboration between the artist and Pirelli's production facilities.

For the occasion, Calvin Cordwell will be working with the shed, dividing it into two spaces: one using natural light ("day") and the other with a greater degree of darkness ("night"). Visitors will visit her key past works – some of which they will be able to activate themselves – which are inspired by the visual language of industrial design, architecture and sculpture. The frames of the exhibition include a reflection on the influence of manufacturing processes on human relationships and on the surrounding environment.

The practice of Calvin Cordwell (J. Paris, 1970) involves the creation of works, with a particular questioning of the boundaries between construction and artistic disciplines. Her work brings together art and architecture in a comprehensive manner, involving the individual's network of relationships with the world, which require concrete change in the form of cultural, economic, social and physical elements that the artist refers to as "Support Structures". She is a co-founder and curator of the Curators Project space in Birmingham. In 2010 she exhibited at Manifesta 8, the European Biennial of Contemporary Art, and in 2014 the Chisenhale Gallery in London and the Van Abbemuseum in Eindhoven devoted two solo exhibitions to her work. In 2008, she wrote and edited a book entitled Support Structures and she has recently published The Company She Keeps.



KOLO MOSER
DESIGN KOLOMAN MOSER, 1905

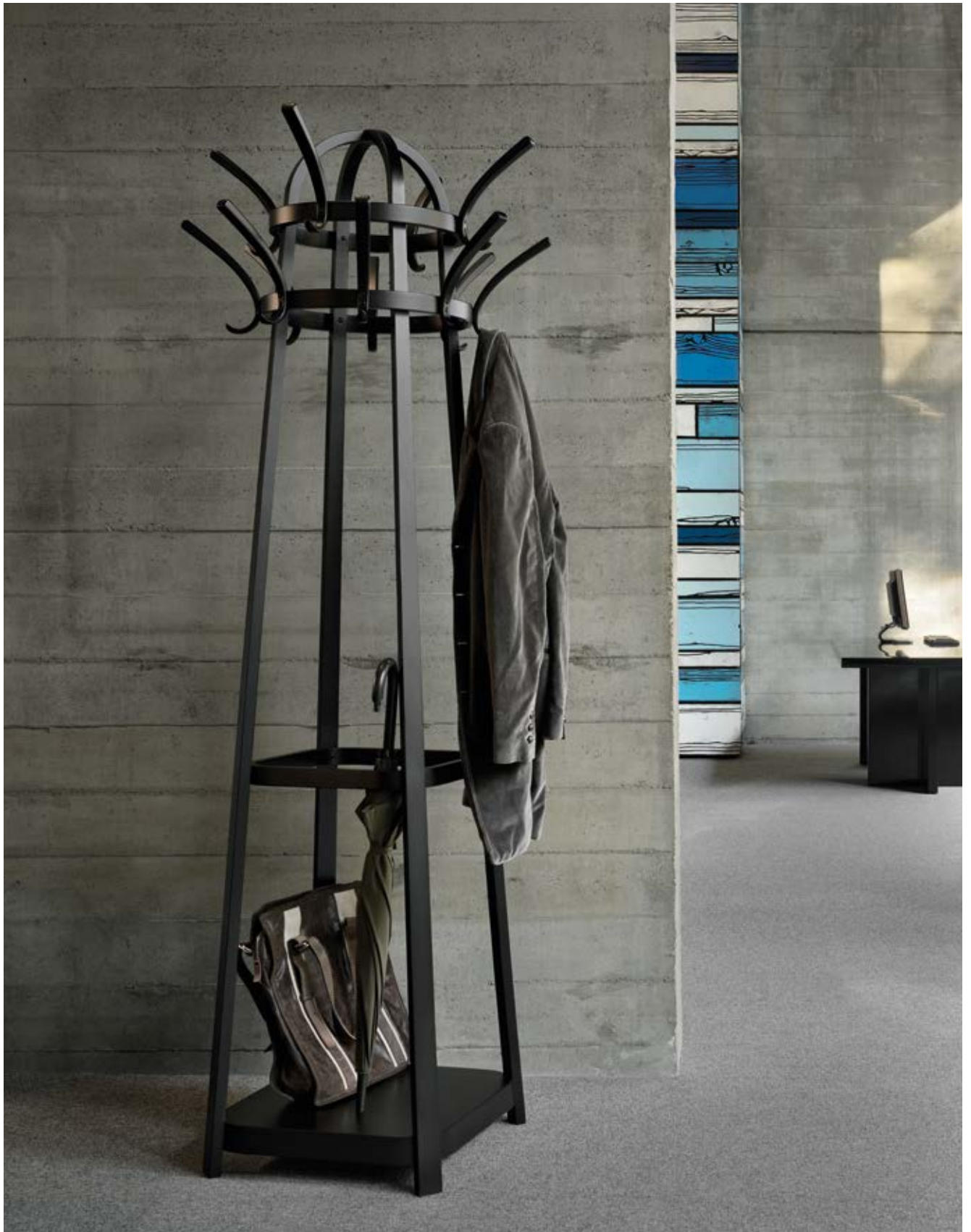

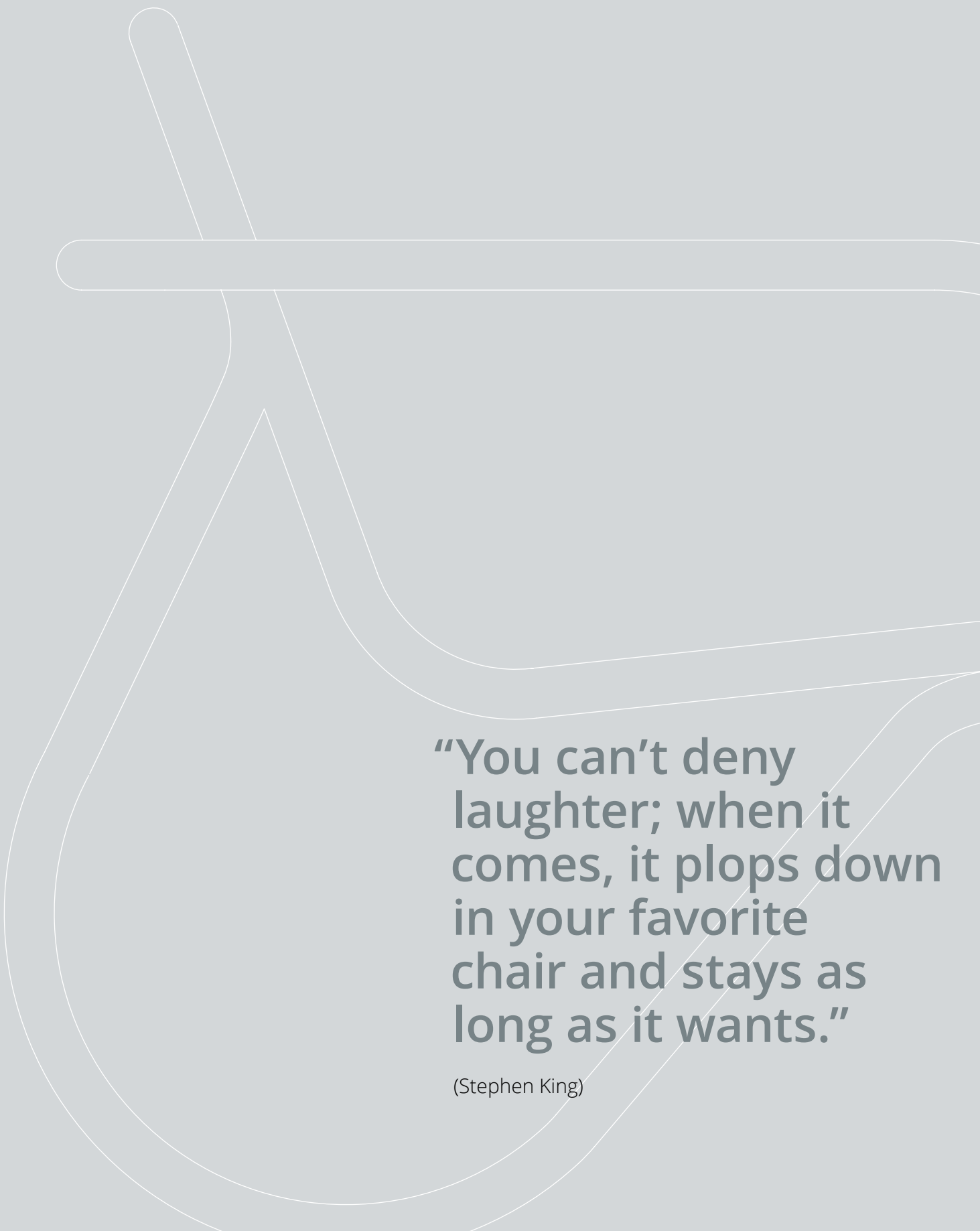

**“You can’t deny
laughter; when it
comes, it plops down
in your favorite
chair and stays as
long as it wants.”**

(Stephen King)

LADDER

DESIGN CHARLIE STYRBJÖRN NILSSON, 2014





MAJORDOMO

DESIGN NATHAN YONG, 2016



ARCH CLOTHES VALET

DESIGN FRONT, 2014



STOCKSSEL

DESIGN GEBRÜDER THONET, 1866





WAGASA

DESIGN SERVOMUTO, 2017





WALTZ
DESIGN GAMFRATESI, 2016





AROUND COLORS RUGS COLLECTION
DESIGN PAOLA PASTORINI, 2021





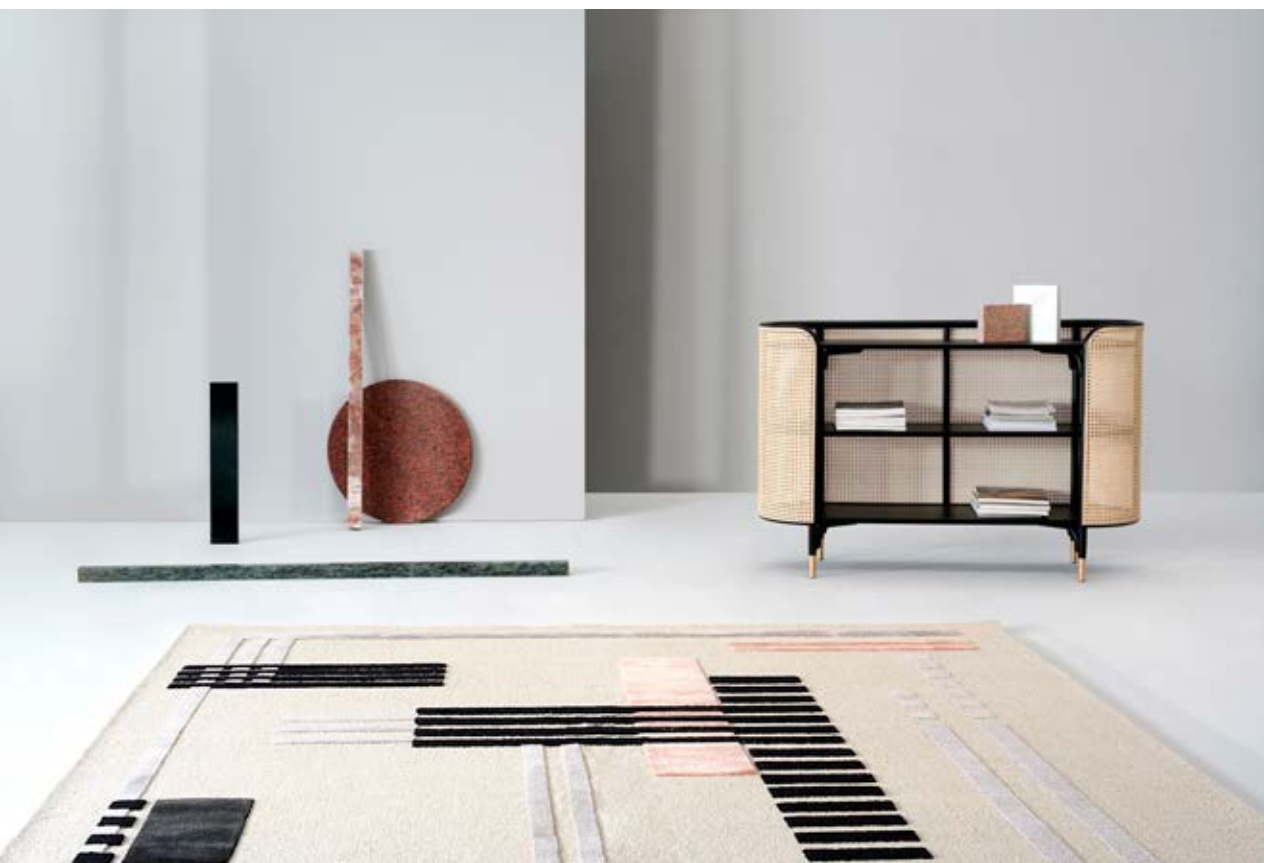



CURVED CUSHIONS COLLECTION
DESIGN PAOLA PASTORINI, 2021













ABACUS

ALPHABETICAL SUMMARY

Allegory Desk 254	Kleiderständer 264	Promenade 164
Arch Clothes Valet 271	Kleiderständer P29 265	Radetzky 92
Arch Coffee Table 242	Kolo Moser 266	Rehbeintisch 222
Arch Dining Table 210	Ladder 268	Ring Dining Table 226
Around Colors Rugs Collection 278	Lehnstuhl 150	Rue 204
Beaulieu 36	Loie 156	Ruhering 117
Bistrotstuhl 42	Loos Café Museum 62	Rum 237
Bodystuhl 44	Magistretti 64	Säule 228
Brezel 48	Majordomo 270	Schaukelstuhl 168
Caféstuhl 50	Malit 66	Sherry 238
Caryllon 212	Morris 68	Single Curve 122
Chignon 132	Mos 182	Sölden 96
Cirque 114	N. 0 70	Stocksessel 272
Cloud 256	N. 1 74	Sugiloo 102
Coat Rack Bench 118	N. 14 76	Suzenne 170
Cognac 234	N. 18 78	Targa 176
Curved Cushions Collection 282	N. 200 160	Trio 128
Czech 52	N. 811 80	Vermouth 240
Duet 244	Nyny 190	Vienna 144 108
Eyeshine Mirrors 257	Ottow 200	Vienna 144 Hocker And Barhocker 130
Feng 258	Pastis 235	Wagasa 274
Furia 262	Peers 246	Waltz 276
Gustav 60	Pince 84	Wiener Box 250
Hideout 136	Porto 236	Wiener Stuhl 110
Hold On 140	Post Mundus 86	Yvette 208
Jannis 142	Postsparkasse 88	

TECHNICAL SHEET

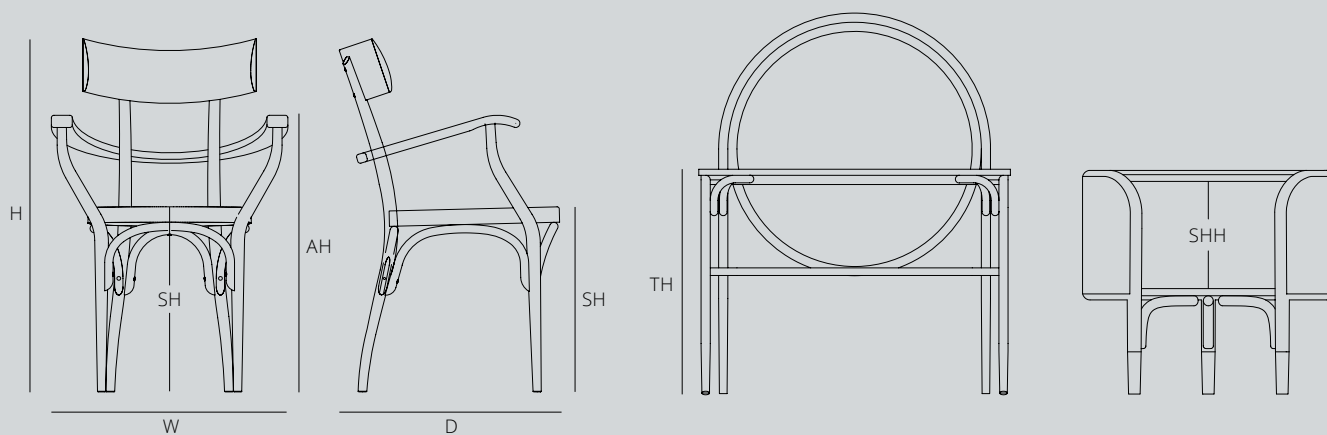

Key to Dimensions:

H	W	D	SH	AH	TH	SHH
Height	Width	Depth	Seat Height	Arm Height	Top Height	Shelves Height
Höhe	Breite	Tiefe	Sitzhöhe	Höhe Armlehne	Höhe Platte	Höhe der Regale
Altezza	Larghezza	Profondità	Altezza Seduta	Altezza Bracciolo	Altezza Top	Altezza Scaffali
Hauteur	Largeur	Profondeur	Hauteur Assise	Hauteur Accoudoir	Hauteur Top	Hauteur des étagères

Ash-wood is open pore painted
Eschenholz ist offenporig lackiert
L'essenza frassino è verniciata a poro aperto
Le bois de cendre est verni à pores ouverts

WOODS & FINISHES

Solid Wood

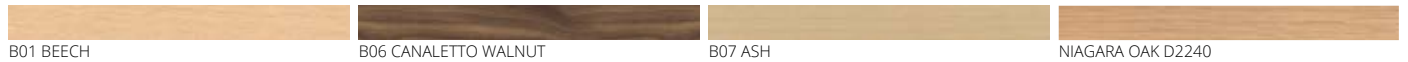

Stains



Classic Lacquer

*Ash wood is open-pore painted



Contemporary Lacquer

*Ash wood is open-pore painted

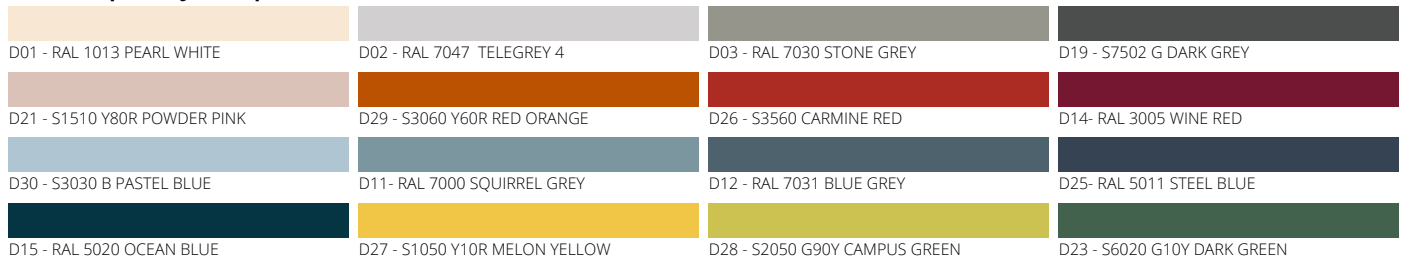

Laminate Top

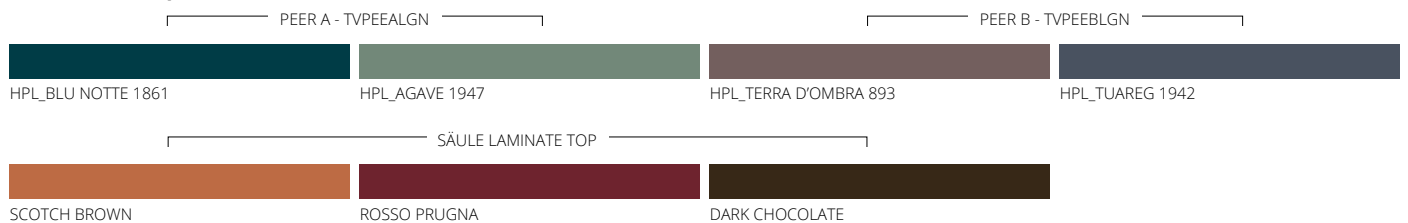

Inlay Tops (Caryllon)



Lampshades (Wagasa)



Version 1

Blaue Posamenterie mit orangefarbener Einfassung
Bezugsstoff Kvadrat Reflex 449

Passamaneria Blu con bordino arancione
Tessuto Kvadrat Reflex 449

Blue trimming with orange edge band
Kvadrat Reflex 449 fabric

Passementerie bleue avec bordure orange
Tissu Kvadrat Reflex 449

Version 2

Blaue Posamenterie mit schwarzer Einfassung
Bezugsstoff Kvadrat Fuse col 631

Passamaneria Blu con bordino nero
Tessuto Kvadrat Fuse col 631

Blue trimming with black edge band
Kvadrat Fuse 631 fabric

Passementerie bleue avec bordure noire
Tissu Kvadrat Fuse col 631

Version 3

Orangefarbene Posamenterie mit schwarzer Einfassung
Bezugsstoff Kvadrat Fuse col 351

Passamaneria Arancione con bordino nero
Tessuto Kvadrat Fuse col 351

Orange trimming with black edge band
Kvadrat Fuse 351 fabric

Passementerie Orange avec bordure noire
Tissu Kvadrat Fuse col 351

Version 4

Orangefarbene Posamenterie mit schwarzer Einfassung
Bezugsstoff Kvadrat Fuse col 981

Passamaneria Arancione con bordino nero
Tessuto Kvadrat Fuse col 981

Orange trimming with black edge band
Kvadrat Fuse 981 fabric

Passementerie Orange avec bordure noire
Tissu Kvadrat Fuse col 981

Version 5

Grün Posamenterie mit schwarzer Einfassung
Bezugsstoff Kvadrat Reflex col 159

Passamaneria Verde con bordino nero
Tessuto Kvadrat Reflex col 159

Green trimming with black edge band
Kvadrat Reflex col 159 fabric

Passementerie Vert avec bordure noire
Tissu Kvadrat Reflex col 159

BEAULIEU

Bent beech-wood chair and armchair available with plywood or upholstered seat.

Stuhl mit oder ohne Armlehnen aus Buchenbugholz mit Sitz aus Schichtholz oder gepolstert.

Sedia e poltroncina in faggio curvato disponibile con seduta in compensato o imbottita.

Chaise et petit fauteuil en hêtre cintré. Assise en contreplaqué ou rembourrée.

FINISHES:
B01, B03, B04, B08, Classic, Contemporary



SDBEAULGN
Dimensions mm.
mm. H 765 | W 505 | D 550 | SH 450

SDBEAUTES
Dimensions mm.
mm. H 765 | W 505 | D 550 | SH 450

PTBEAULGN
Dimensions mm.
mm. H 765 | W 505 | D 550 | SH 450 | AH 640

PTBEAUTES
Dimensions mm.
mm. H 765 | W 505 | D 550 | SH 450 | AH 640

BISTROTSTUHL

Bent beech-wood armchair.
Upholstered or plywood seat.

Armstuhl aus Buchenbugholz. Sitz aus Schichtholz oder gepolstert.

Poltroncina in faggio curvato.
Seduta in multistrato o imbottita.

Petit fauteuil en hêtre cintré. Assise en contreplaqué ou rembourrée.



FINISHES:
B01, Classic

PTCAFELGN
Dimensions mm.
H 770 | W 580 | D 500 | SH 450 | AH 640

PTCAFETES
Dimensions mm.
H 770 | W 580 | D 500 | SH 450 | AH 640

BODYSTUHL

Bent beech-wood chair. 3 versions: woven cane seat and backrest, upholstered seat and woven cane backrest, upholstered seat and backrest.

Stuhl aus Buchenbugholz. 3 Versionen: Sitz und Rückenlehne aus Wiener Geflecht, gepolsterter Sitz und Rückenlehne aus Wiener Geflecht, gepolsterter Sitz und Rückenlehne.

Sedia in faggio curvato. 3 versioni: seduta e schienale in paglia di Vienna, seduta imbottita e schienale in paglia di Vienna, seduta e schienale imbottiti.

Chaise en hêtre cintré. 3 versions: assise et dossier en paille de Vienne, assise rembourrée et dossier en paille de Vienne, assise et dossier rembourrés.



FINISHES:
Classic

SDLEHNPG1
Dimensions mm.
H 800 | W 580 | D 580 | SH 470

SDLEHNTE1
Dimensions mm.
H 800 | W 580 | D 580 | SH 470

SDLEHNTE2
Dimensions mm.
H 800 | W 580 | D 580 | SH 470

BREZEL

Bent beech-wood armchair with upholstered seat.

Stuhl aus Buchenbugholz mit gepolstertem Sitz.

Poltroncina in faggio curvato con seduta imbottita.

Petit fauteuil en hêtre cintré avec assise rembourrée.



FINISHES:
Classic, Contemporary

PLBREZTE1
Dimensions mm.
H 770 | W 560 | D 540 | SH 480 | AH 720

CAFÉSTUHL

Bent beech-wood chair with upholstered or plywood seat.

Stuhl aus Buchenbugholz mit Sitz aus Schichtholz oder gepolstert.

Sedia in faggio curvato, con seduta in multistrato o imbottita.

Chaise en hêtre cintré avec assise en contreplaqué ou rembourrée.



FINISHES:
B01, Classic

SDCAFELGN
Dimensions mm.
H 840 | W 560 | D 510 | SH 460

SDCAFETES
Dimensions mm.
H 840 | W 560 | D 510 | SH 460

CZECH

Bent beech-wood chair and arm-chair, with plywood or upholstered seat. The lacquered version is available with or without natural beech feet.

Stuhl aus Buchenbugholz mit oder ohne Armlehnen. Sitz aus Schichtholz oder gepolstert. In der lackierten Ausführung mit oder ohne FüÙe in Buche Natur verfügbar.

Sedia e poltroncina in faggio curvato, con seduta in multistrato o imbottita. La versione laccata è disponibile con o senza gambaleto in faggio naturale.

Chaise et petit fauteuil en hêtre cintré, avec assise en contreplaqué ou rembourrée; la version laquée est disponible avec ou sans les pieds en hêtre naturel.

FINISHES:
B01, B03, B04, B08, Classic, Contemporary



SDCZECLGN
Dimensions mm.
H 850 | W 420 | D 510 | SH 450



SDCZECTES
Dimensions mm.
H 850 | W 420 | D 510 | SH 450



PTCZECLGN
Dimensions mm.
H 850 | W 550 | D 510 | SH 450 | AH 680



PTCZECTES
Dimensions mm.
H 850 | W 550 | D 510 | SH 450 | AH 680

GUSTAV

Bent beech-wood stackable chair (Max. 4). Plywood or upholstered seat.

Stuhl aus Buchenbugholz, stapelbar (Max. 4). Sitz aus Schichtholz oder gepolstert.

Sedia in faggio curvato, impilabile (Max. 4). Seduta in multistrato o imbottita.

Chaise en hêtre cintré, empilable (Max. 4). Assise en contreplaqué ou rembourrée.



SDGUSTLGN
Dimensions mm.
H 780 | W 590 | D 520 | SH 460 | AH 600



SDGUSTTES
Dimensions mm.
H 780 | W 590 | D 520 | SH 460 | AH 600



Stapelbar (Max. 4)
Impilabile (Max. 4)
Stackable (Max. 4)
Empilable (Max. 4)

FINISHES:
B01, B03, B04, B08, Classic, Contemporary

LOOS CAFÉ MUSEUM

Bent beech-wood chair with elliptical section. Woven cane, plywood or upholstered seat.

Stuhl aus Buchenbugholz mit elliptischem Schnitt. Sitz aus Wiener Geflecht, Schichtholz oder gepolstert.

Sedia in faggio curvato a sezione ellittica. Seduta in paglia di Vienna, in multistrato o imbottita.

Chaise en hêtre cintré à section à ellipse. Assise en paille de Vienne, en contreplaqué ou rembourrée.



FINISHES:
B01, B03, B04, B08, Classic

SDLOOSLGN
Dimensions mm.
H 870 | W 440 | D 530 | SH 470

SDLOOSPLG
Dimensions mm.
H 870 | W 440 | D 530 | SH 470

SDLOOSTES
Dimensions mm.
H 870 | W 440 | D 530 | SH 470

MAGISTRETTI O301

Bent beech-wood armchair. Beech plywood shell, also available with saddle leather covering.

Stuhl aus Buchenbugholz. Sitzschale aus Buchenschichtholz, erhältlich auch mit Lederbezug in den Farben der Kollektion.

Poltroncina in faggio curvato. Scocca in multistrato di faggio disponibile con rivestimento in cuoio nei colori di collezione.

Petit fauteuil en hêtre cintré. Coque en hêtre contreplaqué disponible aussi avec un revêtement en cuir aux couleurs de la collection.



FINISHES:
B01, B03, B04, B08, Classic, Contemporary

SDMAGILGN
Dimensions mm.
H 780 | W 600 | D 600 | SH 450 | AH 610

SDMAGITES
Dimensions mm.
H 780 | W 600 | D 600 | SH 450 | AH 610

MALIT

Armchair with padded structure in flexible cold-foam polyurethane. Base in bent beech-wood. Upholstery in velvet not available.

Sessel in Monocoque-Struktur und Polsterung aus flexiblem, kaltgeschäumtem Polyurethan. Fuß aus Buchenbugholz. Polsterung mit Samt nicht verfügbar.

Poltroncina con struttura monoscocca imbottita in poliuretano flessibile schiumato a freddo. Base in legno di faggio curvato. Rivestimento in velluto non disponibile.

Fauteuil à structure monocoque rembourrée en polyuréthane flexible écumé à froid. Base en bois de hêtre cintré. Rembourrage en velours pas disponible.



FINISHES:
B01, B03, B04, B08, Classic

PTMALATES
Dimensions mm.
H 830 | W 540 | D 540 | SH 450 | AH 680

MORRIS

Bent beech-wood chair. Upholstered seat and woven cane backrest. Available in two heights.

Stuhl aus Buchenbugholz. Sitz gepolstert, Rückenlehne aus Wiener Geflecht, verfügbar in zwei Höhen.

Sedia in faggio curvato. Seduta imbottita e schienale in paglia di Vienna, disponibile in due altezze.

Chaise en hêtre cintré. Assise rembourrée et dossier en paille de Vienne disponible en deux hauteurs.



FINISHES:
B01, B03, B04, B08, Classic, Contemporary

SDMORATES
Dimensions mm.
H 1120 | W 420 | D 530 | SH 450

SDMORBTES
Dimensions mm.
H 840 | W 420 | D 490 | SH 450

N. O

Bent beech-wood chair with one armrest. Upholstered seat and back in woven cane or technical net. Also available with 2 armrests or without armrests.

Stuhl mit einer Armlehne aus Buchenbugholz. Gepolsterter Sitz und Rückenlehne aus Wiener Geflecht oder technischem Netz. Auch erhältlich mit 2 Armlehnen oder ohne Armlehnen.

Sedia con un bracciolo in faggio curvato. Sedile imbottito e schienale in paglia di Vienna o in rete tecnica. Disponibile anche con 2 braccioli o senza.

Chaise avec un accoudoir en hêtre cintré. Assise rembourrée et dossier en paille de Vienne ou en résille technique. Également disponible avec 2 accoudoirs ou sans accoudoirs.



FINISHES:
B01, B03, B04, B08, Classic, Contemporary

SDZEROTES
Dimensions mm.
H 870 | W 480 | D 515 | SH 470

SDZEROTEX
Dimensions mm.
H 870 | W 525 | D 515 | SH 470 | AH 650

N. 1

Bent beech-wood chair. Woven cane seat.

Stuhl aus Buchenbugholz. Sitz aus Wiener Geflecht.

Sedia in faggio curvato. Seduta in paglia di Vienna.

Chaise en hêtre cintré. Assise en paille de Vienne.



FINISHES:
B01, B03, B04, B08, Classic

SDN001PGL
Dimensions mm.
H 920 | W 420 | D 490 | SH 470

N. 14

Bent beech-wood chair. Seat available in wovencane, plywood, perforated plywood or upholstered. Also available in the special version ANNIVERSARIO with a ring-shaped backrest and wovencane seat.

Sedia in faggio curvato. Seduta in paglia di Vienna, in multistrato anche traforato o imbottita. Disponibile nella versione speciale ANNIVERSARIO con schienale in faggio curvato ad anello e seduta in paglia di Vienna.

Stuhl aus Buchenbugholz. Sitz aus Wiener Geflecht, Schichtholz auch mit Lochmuster oder gepolstert. Erhältlich in der speziellen ANNIVERSARIO-Version mit ringgebogener Buche-Rückenlehne und Wiener Strohsitz.

Chaise en hêtre cintré. Assise en paille de Vienne, en contreplaqué aussi ajouré, ou rembourrée. Disponible dans la version spéciale ANNIVERSARIO avec dossier en hêtre cintré et assise en paille de Vienne.



FINISHES:
B01, B03, B04, B08, Classic, Contemporary

SDN014LGN
Dimensions mm.
H 900 | W 410 | D 490 | SH 450

SDN014LGF
Dimensions mm.
H 900 | W 410 | D 490 | SH 450

SDN014PGL
Dimensions mm.
H 900 | W 410 | D 490 | SH 450



SDN014TES
Dimensions mm.
H 900 | W 410 | D 490 | SH 450

SDN014ANN
Dimensions mm.
H 900 | W 410 | D 490 | SH 450

N. 18

Bent beech-wood chair. Plywood or upholstered seat available.

Sedia in faggio curvato. Seduta in multistrato o imbottita.

Stuhl aus Buchenbugholz. Sitz aus Schichtholz oder gepolstert.

Chaise en hêtre cintré. Assise en contreplaqué ou rembourrée.



FINISHES:
B01, B03, B04, B08, Classic, Contemporary

SDN018LGN
Dimensions mm.
H 890 | W 440 | D 490 | SH 470

SDN018TES
Dimensions mm.
H 890 | W 440 | D 490 | SH 470

N. 811

Bent beech-wood chair and armchair. Available in 3 versions: woven cane seat and backrest, upholstered seat and woven cane backrest, upholstered seat and backrest.

Stuhl mit oder ohne Armlehnen aus Buchenbugholz. Erhältlich in 3 Versionen: Sitz und Rückenlehne aus Wiener Geflecht, gepolsterter Sitz und Rückenlehne aus Wiener Geflecht, gepolsterter Sitz und Rückenlehne.

Sedia e poltroncina in faggio curvato. Disponibili in 3 versioni: seduta e schienale in paglia di Vienna, seduta imbottita e schienale in paglia di Vienna, seduta e schienale imbottiti.

Chaise et petit fauteuil en hêtre cintré. Disponibles en 3 versions: assise et dossier en paille de Vienne, assise rembourrée et dossier en paille de Vienne, assise et dossier rembourrés.



FINISHES:
B01, B03, B04, B08, Classic, Contemporary

SD0811PGL
Dimensions mm.
H 820 | W 450 | D 480 | SH 490

SD0811TES
Dimensions mm.
H 820 | W 450 | D 480 | SH 490

SD0811TEZ
Dimensions mm.
H 820 | W 450 | D 480 | SH 490



PT0811PGL
Dimensions mm.
H 820 | W 510 | D 510 | SH 490 | AH 700

PT0811TES
Dimensions mm.
H 820 | W 510 | D 510 | SH 490 | AH 700

PT0811TEZ
Dimensions mm.
H 820 | W 510 | D 510 | SH 490 | AH 700

PINCE

Armchair with padded structure and steel insert in flexible coldfoam polyurethane. Legs and back in bent ash-wood.

Sessel in Monocoque-Struktur mit Stahleinlage und Polsterung aus flexiblem, kalt-geschäumtem Polyurethan. Beine und Rückenlehne aus Eschenbugholz.

Poltroncina con struttura monosocca con inserto in acciaio e imbottitura in poliuretano flessibile schiumato a freddo. Gambe e schienale in legno di frassino curvato.

Fauteuil à structure monocoque doté de parties en acier et rembourré en polyuréthane flexible écumé à froid. Pieds et dossier en bois de frêne cintré.



FINISHES:
B03, B04, B07, Classic

PTPINCTES
Dimensions mm.
H 780 | W 560 | D 530 | SH 450 | AH 660

POST MUNDUS

Bent beech-wood chair. Plywood or upholstered seat available.

Stuhl aus Buchenbugholz. Sitz aus Schichtholz oder gepolstert.

Sedia in faggio curvato. La seduta è disponibile in multistrato o imbottita.

Chaise en hêtre cintré. L'assise est disponible en contreplaqué ou rembourrée.



FINISHES:
B01, Classic

SDPMUNLGN
Dimensions mm.
H 850 | W 480 | D 540 | SH 460

SDPMUNTES
Dimensions mm.
H 850 | W 480 | D 540 | SH 460

POSTSPARKASSE

Bent beech-wood armchair. With perforated plywood or upholstered seat. Available with or without aluminium or copper details.

Armstuhl aus Buchenbugholz. Sitz aus Schichtholz mit Lochmuster oder gepolstert. Mit oder ohne Aluminium- oder Kupferbeschläge.

Poltroncina in faggio curvato. La seduta è disponibile in multistrato traforato o imbottita. Disponibile con o senza dettagli in alluminio o rame.

Petit fauteuil en hêtre cintré. Assise en contreplaqué ajouré ou rembourrée. Disponible avec ou sans les détails en aluminium ou cuivre.

FINISHES:
B01, B03, B04, B08, Classic



PTPSTKLGN
Dimensions mm.
H 790 | W 560 | D 590 | SH 470 | AH 790

PTPSTKLG
With aluminium details
Dimensions mm.
H 790 | W 560 | D 590 | SH 470 | AH 790

PTPSTKLGR
With copper details

PTPSTKTES
Dimensions mm.
H 790 | W 560 | D 590 | SH 470 | AH 790

PTPSTKTEA
With aluminium details
Dimensions mm.
H 790 | W 560 | D 590 | SH 470 | AH 790

PTPSTKTER
With copper details

RADETZKY

Bent beech-wood chair with upholstered or plywood seat.

Sedia in faggio curvato con seduta in multistrato oppure imbottita.

Stuhl aus Buchenbugholz mit Sitz aus Schichtholz oder gepolstert.

Chaise en hêtre cintré avec assise en contreplaqué ou rembourrée.



FINISHES:
B01, B03, B04, B08, Classic, Contemporary

SDRADELGN
Dimensions mm.
H 800 | W 520 | D 500 | SH 450

SDRADETES
Dimensions mm.
H 800 | W 520 | D 500 | SH 450

SÖLDEN

Bent beech-wood chair. Upholstered seat and woven cane backrest. Also available with Canaletto walnut structure.

Sedia in faggio curvato. Seduta imbottita e schienale in paglia di Vienna. Disponibile anche con struttura in noce Canaletto.

Stuhl aus Buchenbugholz. Sitz gepolstert, Rückenlehne aus Wiener Geflecht. Erhältlich auch mit Gestell aus Canaletto Walnuss.

Chaise en hêtre cintré. Assise rembourrée et dossier en paille de Vienne. Également disponible avec structure en noix Canaletto.



FINISHES:
B01, B06, B03, B04, B08, Classic, Contemporary

SDSOLDTES
Dimensions mm.
H 840 | W 490 | D 530 | SH 450

SDSONCTES
Dimensions mm.
H 840 | W 490 | D 530 | SH 450

SUGILOO

Bent beech-wood chair and armchair, available in plywood seat or upholstered seat with plywood backrest.

Sedia e poltroncina, disponibile con seduta in multistrato di faggio o con seduta imbottita e schienale in multistrato di faggio.

Stuhl und Sessel, erhältlich mit Sitz aus Buchensperrholz oder mit gepolstertem Sitz und Rückenlehne aus Buchensperrholz.

Chaise et petit fauteuil en hêtre cintré, disponible avec assise en contreplaqué de hêtre ou avec assise rembourrés et dossier en contreplaqué de hêtre.



FINISHES:
B01, B03, B04, B08, Classic, Contemporary

PTSUGILGN
Dimensions mm.
H 820 | W 540 | D 540 | SH 460 | AH 660

PTSUGITE2
Dimensions mm.
H 820 | W 540 | D 540 | SH 460 | AH 660

SDSUGILGN
Dimensions mm.
H 820 | W 420 | D 470 | SH 460

→ SUGILOO



SDSUGITE2
Dimensions mm.
H 820 | W 420 | D 470 | SH 460

VIENNA 144

Bent beech-wood chair. Seat available in woven cane, with stripe pattern plywood, upholstered or upholstered backrest and seat. Also available the armchair with stripe pattern plywood seat.

Stuhl aus Buchenbugholz. Sitz aus Wiener Geflecht, Schichtholz mit Relief, gepolstert oder auch mit gepolsterter Rückenlehne und gepolsterter Sitz. Erhältlich auch den Stuhl mit Armlehnen, mit Sitz aus Schichtholz mit Relief.

Sedia in faggio curvato. Seduta disponibile in paglia di Vienna, in multistrato stampato a rilievo, imbottita o anche con schienale e seduta imbottiti. Disponibile anche la versione con braccioli con seduta in multistrato stampato a rilievo.

Chaise en hêtre cintré. Assise disponible en paille de Vienne, contreplaqué avec impression en relief, rembourré ou avec le dossier et l'assise rembourrés. Disponible également le fauteuil avec assise en contreplaqué avec impression en relief.

FINISHES:
Classic, Contemporary



SDV144LGN
Dimensions mm.
H 940 | W 380 | D 550 | SH 450



SDV144PGL
Dimensions mm.
H 940 | W 380 | D 550 | SH 450



SDV144TES
Dimensions mm.
H 940 | W 380 | D 550 | SH 450



SDV144TE2
Dimensions mm.
H 940 | W 380 | D 550 | SH 450



PTV144LGN
Dimensions mm.
H 940 | W 550 | D 600 | SH 450 | AH 650

WIENER STUHL

Bent beech-wood armchair. Woven cane, plywood, perforated plywood, upholstered seat or upholstered seat and backrest available. The frame is also available in two tones (rear legs in natural beech and lacquered structure as per standard collection colors).

Armstuhl aus Buchenbugholz. Sitz aus Wiener Geflecht, gebogenem Schichtholz (auch mit Lochmuster), gepolstert oder Gepolsterte Sitz und Rückenlehne Gestell auch in zweifarbiger Ausführung (Hinterbeinen in Buche Natur und lackierte Struktur in den Farben der Kollektion).

Poltroncina in faggio curvato. La seduta è disponibile in paglia di Vienna, in multistrato curvato anche traforato, imbottita o con seduta e schienale imbottiti. La struttura è disponibile anche bi-color (gambe posteriori in faggio naturale e struttura laccata nei colori di collezione).

Petit fauteuil en hêtre cintré. L'assise est disponible en paille de Vienne, en contreplaqué cintré et même ajouré, rembourrée ou encore avec assise et dossier rembourrés. La structure est aussi disponible bicolore (jambes arrières en hêtre naturel et structure laquée dans les couleurs de la collection).

FINISHES:

ONE TONE: B01, B03, B04, B08, Classic, Contemporary

TWO TONE: Rear Legs: B01

Front legs and frame: Classic, Contemporary



PTWIESLGN
Dimensions mm.
H 800 | W 520 | D 570 | SH 470 | AH 710

PTWIESLGF
Dimensions mm.
H 800 | W 520 | D 570 | SH 470 | AH 710

PTWIESPGL
Dimensions mm.
H 800 | W 520 | D 570 | SH 470 | AH 710

PTWIESTES
Dimensions mm.
H 800 | W 520 | D 570 | SH 470 | AH 710

PTWIESTE2
Dimensions mm.
H 800 | W 520 | D 570 | SH 470 | AH 710

STOOLS

CIRQUE

Bent beech-wood stool in two heights. Barstool version also with backrest. Upholstered or plywood seat available. Also with brushed brass-finish metal rings.

Hocker aus Buchenbugholz in zwei Höhen erhältlich. Barhocker auch mit Rueckenlehne erhältlich. Sitz aus Schichtholz oder gepolstert. Erhältlich auch mit Ringen aus Metall, Messing matt.

Sgabello in faggio curvato disponibile in due altezze. Lo sgabello alto è disponibile anche con schienale. Seduta imbottita oppure in multistrato. Disponibile versione con cerchi in metallo, finitura ottone satinato.

Tabouret en hêtre cintré disponibles en deux hauteurs. Le tabouret bar est également disponible avec un dossier. Assise disponible rembourrée ou en contreplaqué. Version disponible avec anneaux en métal, finition laiton satiné.



FINISHES:
ONE TONE: B01, B03, B04, B08, Classic, Contemporary
TWO TONE: C01/C02, B01/B03
BRASS RING: B01, B03, Classic

SGCIRSLGN
Dimensions mm.
H 470 | W 410 | D 410

SGCIRSTES
Dimensions mm.
H 470 | W 410 | D 410

SGCIRSLGA (Brushed brass-finish metal rings)

SGCIRSTEA (Brushed brass-finish metal rings)



SGCIRMLGN
Dimensions mm.
H 780 | W 440 | D 440

SGCIRMTES
Dimensions mm.
H 780 | W 440 | D 440

SGCIRLLGN
Dimensions mm.
H 970 | W 440 | D 440 | SH 780 | AH 970

SGCIRLTES
Dimensions mm.
H 970 | W 440 | D 440 | SH 780 | AH 970

SGCIRMLGA (Brushed brass-finish metal rings)

SGCIRMTEA (Brushed brass-finish metal rings)

SGCIRLLGA (Brushed brass-finish metal rings)

SGCIRLTEA (Brushed brass-finish metal rings)

N. 18 BARSTOOL

Bent beech-wood barstool. Plywood or upholstered seat available.

Barhocker aus Buchenbugholz. Sitz aus Schichtholz oder gepolstert.

Sgabello da bar in faggio curvato. Seduta in multistrato o imbottita.

Tabouret bar en hêtre cintré. Assise en contreplaqué ou rembourrée.



FINISHES:
B01, B03, B04, B08, Classic, Contemporary

SAN018LGN
Dimensions mm.
H 1110 | W 415 | D 500 | SH 760

SAN018TES
Dimensions mm.
H 1110 | W 415 | D 500 | SH 760

N. 811 BARSTOOL

Bent beech-wood barstool.

Available in 3 versions: woven cane seat and backrest, upholstered seat and woven cane backrest, upholstered seat and backrest.

Sgabello da bar in faggio curvato.

Disponibile in 3 versioni: seduta e schienale in paglia di Vienna, seduta imbottita e schienale in paglia di Vienna, seduta e schienale imbottiti.

Barhocker aus Buchenbugholz.

Erhältlich in 3 Versionen: Sitz und Rückenlehne aus Wiener Geflecht, gepolsterter Sitz und Rückenlehne aus Wiener Geflecht, gepolsterte Sitz und Rückenlehne.

Tabouret bar en hêtre cintré.

Disponible en 3 versions: assise et dossier en paille de Vienne, assise rembourrée et dossier en paille de Vienne, assise et dossier rembourrés.



FINISHES:

B01, B03, B04, B08, Classic, Contemporary

SA0811PGL

Dimensions mm.
H 1085 | W 410 | D 500 | SH 750

SA0811TES

Dimensions mm.
H 1085 | W 410 | D 500 | SH 750

SA0811TE2

Dimensions mm.
H 1085 | W 410 | D 500 | SH 750

POSTSPARKASSE HOCKER

Bent beech-wood stool. Plywood seat. Visible metal details.

Sgabello in faggio curvato. Seduta in multistrato. Dettagli metallici a vista.

Hocker aus Buchenbugholz. Sitz aus Schichtholz. Mit Zierbeschlägen aus Metall.

Tabouret en hêtre cintré. Assise en contreplaqué. Détails apparents en métal.



FINISHES:

B01, B03, B04, B08, Classic

SGPSTKLGN

Dimensions mm.
H 480 | W 420 | D 420

SINGLE CURVE BARSTOOL

Bent beech-wood barstool. Woven cane or plywood seat available. Brass covered footrest.

Sgabello da bar in faggio curvato. La seduta è disponibile in paglia di Vienna o in multistrato. Barra poggiapièdi rivestita in ottone.

Barhocker aus Buchenbugholz. Sitz aus Wiener Geflecht oder Schichtholz. Fußstütze mit Messing beschichtet.

Tabouret bar en hêtre cintré. L'assise est disponible en paille de Vienne ou en contreplaqué. Barre repose-pied recouverte de laiton.



FINISHES:

B01, B03, B04, B08, Classic, Contemporary

SANSTOPGL

Dimensions mm.
H 870 | W 540 | D 420 | SH 740 | AH 870

SANSTOLGN

Dimensions mm.
H 870 | W 540 | D 420 | SH 740 | AH 870

STOOLS

SINGLE CURVE COUNTER

Bent beech-wood counter stool.
Woven cane or plywood seat available. Brass covered footrest.

Counter Hocker aus Buchenbugholz.
Sitz aus Wiener Geflecht oder Schichtholz. Fußstütze mit Messing beschichtet.

Sgabello counter in faggio curvato.
La seduta è disponibile in paglia di Vienna o in multistrato. Barra poggiapiedi rivestita in ottone.

Tabouret bar en hêtre cintré, assise h 65 cm. L'assise est disponible en paille de Vienne ou en contreplaqué. Barre repose-pied recouverte de laiton.



FINISHES:
B01, B03, B04, B08, Classic, Contemporary

SMNSTOLGN
Dimensions mm.
H 780 | W 540 | D 420 | SH 650 | AH 780

SMNSTOPGL
Dimensions mm.
H 780 | W 540 | D 420 | SH 650 | AH 780

SINGLE CURVE STOOL

Bent beech-wood three-leg stool.
Woven cane or plywood seat.

Dreißeiniger Hocker aus Buchenbugholz. Sitz aus Wiener Geflecht oder Schichtholz.

Sgabello a tre gambe. La seduta è in paglia di Vienna o in multistrato.

Tabouret à trois pieds en hêtre cintré. Assise en paille de Vienne ou en contreplaqué.



FINISHES:
B01, B03, B04, B08, Classic, Contemporary

SBNSTOPGL
Dimensions mm.
H 690 | W 480 | D 430 | SH 480 | AH 690

SBNSTOLGN
Dimensions mm.
H 690 | W 480 | D 430 | SH 480 | AH 690

TRIO

Bent beech-wood stool in three heights: bar, counter and low.
Upholstered or plywood seat.

Hocker aus Buchenbugholz in drei Höhen erhältlich: Bar, Counter oder klein. Sitz gepolstert oder aus Schichtholz.

Sgabello in faggio curvato disponibile in tre altezze: bar, counter e basso. Seduta imbottita o in multistrato.

Tabourets en hêtre cintré disponibles en trois hauteurs: assise h.77 cm ou h. 65 cm ou bas. Assise rembourrée ou en contreplaqué.



FINISHES:
B01, B03, B04, B08, Classic, Contemporary

SATRIOLGN
Dimensions mm.
H 770 | W 440 | D 440

SATRIOTES
Dimensions mm.
H 770 | W 440 | D 440

SMTRIOLGN
Dimensions mm.
H 650 | W 440 | D 440

STOOLS

↳ TRIO



SMTRIOOTES
Dimensions mm.
H 650 | W 440 | D 440



SBTRIOOLGN
Dimensions mm.
H 460 | W 400 | D 380



SBTRIOOTES
Dimensions mm.
H 460 | W 400 | D 380

VIENNA 144 HOCKER AND BARHOCKER

Bent beech-wood stool, available in 2 heights. Woven cane, stripe pattern plywood or upholstered seat available. Only for the higher version, footrest comprising a chromed metal ringshaped element.

Hocker aus Buchenbugholz in zwei Höhen. Sitz aus Wiener Geflecht, Schichtholz mit Relief oder gepolstert. Nur für höhere Version mit chromtem Metallring als Fußstütze.

Sgabello in faggio curvato, in due altezze. La seduta è disponibile in paglia di Vienna, in multistrato stampato a rilievo o imbottita. Solo per la versione alta, poggiatesta costituito da un elemento ad anello in metallo cromato.

Tabouret en hêtre cintré, en deux hauteurs. L'assise est disponible en paille de Vienne, en contreplaqué imprimé en relief ou rembourrée. Uniquement pour la version la plus haute, repose-pieds constitué d'un élément en forme d'anneau en métal chromé.



SAV144LGN
Dimensions mm.
H 850 | W 460 | D 460

FINISHES:
B01, B03, B04, B08, Classic, Contemporary



SAV144PGL
Dimensions mm.
H 850 | W 460 | D 460



SAV144TES
Dimensions mm.
H 850 | W 460 | D 460



SBV144LGN
Dimensions mm.
H 450 | W 350 | D 350



SBV144PGL
Dimensions mm.
H 450 | W 350 | D 350



SBV144TES
Dimensions mm.
H 450 | W 350 | D 350

BENCHES

COAT RACK BENCH

Coat rack bench with bent beech-wood frame. Woven cane or upholstered seat.

Bank mit Kleiderständer. Gestell aus Buchenbugholz mit Sitz aus Wiener Geflecht oder Gepolsterte.

Panca appendiabiti con struttura in faggio curvato e seduta in paglia di Vienna o imbottita.

Banc porte-manteaux avec structure en hêtre cintré et assise en paille de Vienne ou rembourrée.



FINISHES:
Classic

PCCOATPGL
Dimensions mm.
H 1880 | W 1360 | D 590 | SH 440

PCCOATTES
Dimensions mm.
H 1880 | W 1360 | D 590 | SH 440

MOS BENCH

Bench with bent beech-wood frame and woven cane inserts. Open-pore painted shelves in ash veneer. Upholstered seat with removable cover. Brass feet

Sitzbank mit dampfgebogenem Buchenholzgestell und eingesetztem Wiener Geflecht. Regale aus offenerigem, lackiertem Eschefurnier. Gepolsterter Sitz mit abnehmbarem Bezug. Messing-Füßen.

Panca con struttura in faggio curvato a vapore e inserti in paglia di Vienna. Ripiani in impiallacciato in frassino verniciato a poro aperto. Seduta imbottita sfoderabile. Puntali in ottone.

Banc avec structure en hêtre cintré et inserts en paille de Vienne. Étagères en plaqué frêne teinté à pores ouverts. Assise rembourrée déhoussable. Pieds en laiton.



FINISHES:
FRAME B01, C01
SHELVES B07, C01

PCMOSGTEP
Dimensions mm.
H 440 | W 1360 | D 430 | SH 370 | SHH 140

PCMOSGTEP + PWMOSGTE2
Dimensions mm.
H 440 | W 1360 | D 430 | SH 440 | SHH 140

PCMOSGTEP + PWMOSGTES
Dimensions mm.
H 440 | W 1360 | D 430 | SH 440 | SHH 140

RUHERING

Multiple seating solution with central coat rack. Metal and bent beech-wood frame with upholstered seats.

Sitzmöbel mit zentraler Kleiderablage. Gestell aus Metall und Buchenbugholz mit gepolsterte Sitzflächen.

Multiseduta con appendiabiti centrale. Struttura in metallo e faggio curvato con sedute imbottite.

Assise multiple avec porte-manteaux central. Structure en métal et hêtre cintré avec assises rembourrées.



FINISHES:
Classic

MSRU22TES
Dimensions mm.
H 1850 | W 1350 | D 1350 | SH 450

CHIGNON

Lounge chair with bent beech-wood frame. Seat and back in polyurethane foam of different densities and polyester fiber.

Poltrona lounge con struttura in faggio curvato. Seduta e schienale in poliuretano espanso a densità differenziate e fibra poliestere.

Loungesessel mit Gestell aus Buchenbugholz. Sitz und Rückenlehne aus Polyurethan Schaumstoff unterschiedlicher Dichte und Polyesterfaser.

Fauteuil lounge avec structure en hêtre cintré. Assise et dossier en polyurethane expansé à densité différenciée et fibre de polyester.



FINISHES:
B01, B03, B04, B08, Classic, Contemporary

PTCHIGTES
Dimensions mm.
H 740 | W 920 | D 820 | SH 450

HIDEOUT

Bent beech-wood lounge chair and two-seater sofa. Upholstered seat and backrest with different density polyurethane foam filling and side elements in woven cane.

Poltrona lounge e divano a due posti in faggio curvato. Seduta e schienale imbottiti in poliuretano espanso a densità differenziata con elementi laterali in paglia di Vienna.

Loungesessel und Zweisitzer-Sofa aus Buche. Sitz und Rückenlehne mit Polsterung aus Schaumstoff mit unterschiedlichen Härtegraden, Seitenelemente aus Wiener Geflecht.

Fauteuil lounge et canapé deux places en hêtre cintré. Assise et dossier rembourrés en polyurethane à densité différenciée avec éléments latéraux en paille de Vienne.



FINISHES:
Classic

LOUNGE, 2015
PLHIDETES
Dimensions mm.
H 1170 | W 740 | D 740 | SH 390

LOVESEAT, 2018
DBHIDETES
Dimensions mm.
H 1170 | W 1460 | D 830 | SH 390

HOLD ON

Daybed and lounge chair with a load-bearing ash-wood frame. Quilted seat cushion and backrest bolster cushion. Different density polyurethane foam filling, covered with acrylic fiber layers.

Daybed e poltrona lounge caratterizzati da struttura portante in frassino. Cuscino di seduta trapuntato e cuscino di schienale a rullo. Imbottitura in poliuretano espanso a densità differenziata, rivestito con falde di fibre acriliche.

Daybed und Lounge-Sessel mit Gestell aus Eschenholz. Mit gesteppter Sitzpolsterung und Rückenrolle als Lehne. Polsterung aus PU-Schaumstoff mit unterschiedlichen Härtegraden, Bezug aus Acrylfaser.

Méridienne et fauteuil lounge caractérisés par une structure portante en frêne. Cossin de l'assise matelassé et cossin du dossier cylindrique. Rembourrage en mousse de polyuréthane à densité différenciée, recouvert de bandes de fibres acryliques.



FINISHES:
B03, B04, B07

PLHOLDTES
Dimensions mm.
H 660 | W 730 | D 840 | SH 300 | AH 660

DBHOLDTES
Dimensions mm.
H 620 | W 1820 | D 820 | SH 300 | AH 620

JANNIS

Collection of upholstered items with bent beech-wood frame and brass decorative elements. Fully removable cover. Upholstered seat with different density polyurethane foam filling, covered with acrylic fiber layers. Cushions made of polyurethane memory foam.

Kollektion von gepolsterten Produkte mit Buchholzgestell aus Buche und Dekoelementen aus Messing. Vollständig abnehmbarer Bezug. Sitzpolsterung aus PU-Schaumstoff mit unterschiedlichen Härtegraden, Bezug aus Acrylfaser. Kissen aus Polyurethanschäum mit Formgedächtnis hergestellt.

Collezione di imbottiti con struttura in faggio curvato ed elementi decorativi in ottone, completamente sfoderabile. Seduta imbottita in poliuretano espanso a densità differenziata, rivestito con falde di fibre acriliche. Cuscini in poliuretano espanso memory foam.

Collection de produits rembourrés avec structure en hêtre cintré et éléments décoratifs en laiton. Complètement déhoussable. Assise rembourrés en mousse de polyuréthane à densité différenciée, recouvert de bandes de fibres acryliques. Coussins en polyuréthane à mousse de mémoire.

FINISHES:
C01



DJANNTES
Dimensions mm.
H 820 | W 2080 | D 800 | SH 420 | AH 610



DBJANNTES
Dimensions mm.
H 820 | W 1450 | D 800 | SH 420 | AH 610



PIJANNTES
Dimensions mm.
H 820 | W 770 | D 800 | SH 420 | AH 610

LEHNSTUHL

Bent beech-wood lounge chair. Available in three versions: large mesh woven cane seat and backrest, upholstered seat and large mesh woven cane backrest or fully upholstered. Bent beech-wood footrest with wide mesh woven cane or upholstered.

Lehnstuhl aus Buchenbugholz. Erhältlich in drei Versionen: Sitz und Rückenlehne aus weitmaschigem Wiener Geflecht, gepolsterter Sitz und Rückenlehne aus weitmaschigem Wiener Geflecht oder beide gepolstert. Fußstütze aus Buchenbugholz und weitmaschigem Wiener Geflecht oder gepolstert.

Lounge chair in faggio curvato. Disponibile in tre versioni: seduta e schienale in paglia di Vienna a maglia larga, seduta imbottita e schienale in paglia di Vienna a maglia larga o tutta imbottita. Poggiapiedi in faggio curvato con paglia di Vienna a maglia larga o imbottito.

Fauteuil lounge en hêtre cintré. Disponible en trois versions: assise et dossier en paille de Vienne à maille large, assise rembourrée et dossier en paille de Vienne à maille large, assise et dossier rembourrés. Repose-pied en hêtre cintré avec paille de Vienne à maille large ou rembourré.

FINISHES:
C01, D03



PLLEHNPGI
Dimensions mm.
H 840 | W 740 | D 830 | SH 410 | AH 570



PLLEHNTES
Dimensions mm.
H 840 | W 740 | D 830 | SH 410 | AH 570



PLLEHTSS
Dimensions mm.
H 840 | W 740 | D 830 | SH 410 | AH 570



PPLEHNPGI
Dimensions mm.
H 420 | W 590 | D 410



PPLEHNTES
Dimensions mm.
H 420 | W 590 | D 410

LOÏE

Lounge chair with woven cane or technical net backrest and elliptical frame in bent solid ash. Metal frame with black powdered lacquer. Seat with fabric woven straps. Upholstered in differentiated density polyurethane foam and goose down.

Armsessel mit Rückenlehne aus Wiener Geflecht oder technischem Netz. Struktur aus gebogenem Eschenholz und Metallsockel. Gepolsterter Sitz.

Poltroncina con schienale in paglia di Vienna o in rete tecnica, struttura in frassino curvato e base in metallo. Seduta imbottita.

Fauteuil avec dossier en paille de Vienne ou en résille technique, structure en frêne cintré et base en métal. Assise rembourrée.



PLLOIETES
Dimensions mm.
H 940 | W 700 | D 740 | SH 420



PLLOIETEX
Dimensions mm.
H 940 | W 700 | D 740 | SH 420

FINISHES:
B03, B07, C01

LOUNGE CHAIRS AND SOFAS

N. 200

Bent beech-wood lounge chair.
Woven cane or upholstered seat
and backrest.

Loungesessel aus Buchenbugholz.
Sitz und Rückenlehne aus Wiener
Geflecht oder gepolstert.

Poltrona lounge in faggio curvato.
Seduta e schienale in paglia di
Vienna o imbottiti.

Fauteuil lounge en hêtre cintré.
Assise et dossier en paille de Vienne
ou rembourrés.



FINISHES:
B01, C01

PLN200PGL
Dimensions mm.
H 730 | W 630 | D 775 | SH 425 | AH 615

PLN200TES
Dimensions mm.
H 730 | W 630 | D 775 | SH 425 | AH 615

PROMENADE

Collection of upholstered items with
removable covers, canaletto walnut
frames with square section profiles.
Backrest panels covered with fabric,
also available with a woven cane
trim on the upper part. Upholstered
in differentiated-density polyure-
thane foam and goose down.

Kollektion an Polstermöbeln mit
herausnehmbaren Polsterzeug
und einer Struktur aus Canaletto
Walnuss. Profile mit quadratischem
Querschnitt. Rückenpartien mit Stoff
bezogen, auch mit einer Umrandung
aus Wiener Geflecht im oberen
Bereich erhältlich. Polsterung aus
aufgeschäumten Polyurethan unter-
schiedlicher Dicke und Gänsedaunen.

Collezione di imbottiti sfoderabili
con struttura in noce canaletto,
profili a sezione quadrata. Pannelli
schienale rivestiti in tessuto, di-
sponibili anche con inserto in
paglia di Vienna nella fascia supe-
riore. Imbottitura in poliuretano
espanso a densità differenziata e
piuma d'oca.

Collection d'articles rembourrés
déhoussables avec une structure
en noyer canaletto, profils section
carrée. Panneaux dossier tapissés,
également disponibles avec une
bordure en paille de Vienne au
niveau de la bande supérieure.
Rembourrage en mousse polyuré-
thane à densité différenciée et en
duvet d'oie.

FINISHES:
B06



DBPROMTES
Dimensions mm.
H 840 | W 1800 | D 900 | SH 400 | AH 690

DLPROMTES
Dimensions mm.
H 840 | W 2300 | D 900 | SH 400 | AH 690

PLPROMTES
Dimensions mm.
H 680 | W 800 | D 800 | SH 400 | AH 690

SCHAUKELSTUHL

Bent beech-wood rocking chair.
Woven cane seat and backrest.

Schaukelstuhl aus Buchenbugholz. Sitz
und Rückenlehne aus Wiener Geflecht.

Dondolo in faggio curvato. Seduta e
schienale in paglia di Vienna.

Chaise à bascule en hêtre cintré.
Assise et dossier en paille de Vienne.



FINISHES:
B01, B03, B04, B08, Classic

DNSCHAPGL
Dimensions mm.
H 1040 | W 520 | D 1040 | SH 490

SUZENNE

Two-seater sofa and lounge chair
with bent beech-wood frame and
woven cane inserts. Upholstered
seat and backrest.

Zweisitzer-Sofa und Loungessel mit
dampfgebogenem Buchenholzgestell
und eingesetztem Wiener Geflecht.
Sitz und Rückenlehne gepolstert.

Divano due posti e lounge chair con
struttura in faggio curvato a vapore
e inserti in paglia di Vienna. Seduta
e schienale imbottiti.

Canapé deux places et fauteuil
lounge avec structure en hêtre
cintré et inserts en paille de Vienne.
Assise et dossier rembourrés.

FINISHES:
C01



DBSUZETES
Dimensions mm.
H 820 | W 1480 | D 780 | SH 430

PLSUZETES
Dimensions mm.
H 820 | W 850 | D 780 | SH 430

TARGA

Collection of upholstered items with bent beech-wood frame and woven cane decorative elements. Seat and backrest with different density polyurethane foam filling, covered with acrylic fiber layers. Also available with brass feet.

Kollektion von gepolsterten produkte mit Bugholzgestell aus Buche und Dekoelementen aus Wiener Geflecht. Polsterung von Sitz und Rückenlehne aus PU-Schaumstoff mit unterschiedlichen Härtegraden, Bezug aus Acrylfaser. Erhältlich auch mit Messing-Füßen.

Collezione di imbottiti con struttura in faggio curvato ed elementi decorativi in paglia di Vienna. Seduta e schienale imbottiti in poliuretano espanso a densità differenziata, rivestito con falde di fibre acriliche. Disponibile anche con piedini in ottone.

Collection de produits rembourrés avec structure en hêtre cintré et éléments décoratifs en paille de Vienne. Assise et dossier rembourrés en mousse de polyurethane à densité différenciée, recouvert de bandes de fibres acryliques. Également disponible avec pieds en laiton.

FINISHES:
B01, C01



DBTARGTES
Dimensions mm.
H 760 | W 1600 | D 840 | SH 400

DBTARGTEP
With brass feet
Dimensions mm.
H 810 | W 1600 | D 840 | SH 450



DLTARGTES
Dimensions mm.
H 760 | W 2000 | D 840 | SH 400

DLTARGTEP
With brass feet
Dimensions mm.
H 810 | W 2000 | D 840 | SH 450



PLTARGTES
Dimensions mm.
H 760 | W 930 | D 840 | SH 400

PLTARGTEP
With brass feet
Dimensions mm.
H 810 | W 930 | D 840 | SH 450



CORNER UNIT, 2018
DMTARGTAN
Dimensions mm.
H 760 | W 750 | D 750 | SH 400

DMTARGPAN
With brass feet
Dimensions mm.
H 810 | W 750 | D 750 | SH 450



CENTRAL UNIT, 2018
DMTARGTCE
Dimensions mm.
H 760 | W 1000 | D 780 | SH 400

DMTARGPCE
With brass feet
Dimensions mm.
H 810 | W 1000 | D 780 | SH 450



LEFT END UNIT, 2018
DMTARGTSX
Dimensions mm.
H 760 | W 1000 | D 780 | SH 400

DMTARGPSX
With brass feet
Dimensions mm.
H 810 | W 1000 | D 780 | SH 450



RIGHT END UNIT, 2018
DMTARGTDX
Dimensions mm.
H 760 | W 1000 | D 780 | SH 400

DMTARGPDX
With brass feet
Dimensions mm.
H 810 | W 1000 | D 780 | SH 450



POTARGTES
Dimensions mm.
H 390 | W 700 | D 700

POTARGTEP
With brass feet
Dimensions mm.
H 440 | W 700 | D 700

MOS BOOKCASE

Freestanding bookcase with bent beech-wood frame and woven cane lateral inserts. Open pore painted shelves in ash veneer. Brass feet.

Libreria "freestanding" con struttura in faggio curvato e inserti laterali in paglia di Vienna. Ripiani in impiallacciato frassino verniciato a poro aperto. Puntali in ottone.

"Freestanding" Bücherregal mit Buchenbugholzgestell und Seiteneinsätze aus Wiener Geflecht. Regale aus offenporigem, lackiertem Eschefurnier. Messing-Füßen.

"Freestanding" bibliothèque avec structure en hêtre cintré et inserts latéraux en paille de Vienne. Étagères en plaqué frêne teinté à pores ouverts. Pieds en laiton.



FINISHES:
B01, B07, C01

LBMOSGPGL
Dimensions mm.
H 1430 | W 1360 | D 430 | SHH 290

MOS CONSOLE

Console with bent beech-wood frame and woven cane lateral and rear panel. Open pore painted shelves in ash veneer. Brass feet.

Consolle con struttura in faggio curvato e pannelli laterali e posteriori in paglia di Vienna. Ripiani impiallacciati in frassino verniciato a poro aperto. Puntali in ottone.

Schrank mit Buchenbugholzgestell und Seiten- und Rückwänden aus Wiener Geflecht. Regale aus offenporigem, lackiertem Eschefurnier. Messing-Füßen.

Console avec structure en hêtre cintré et panneaux latéraux et arrière en paille de Vienne. Étagères en plaqué frêne teinté à pores ouverts. Pieds en laiton.



FINISHES:
B01, B07, C01

CNMOSGPGC
Dimensions mm.
H 910 | W 1360 | D 430 | SHH 290

NYNY DRAWERS

Storage unit made up of two modules in lacquered wood with decorative elements in woven cane. The modules are suspended thanks to the metal structure, with satin brass finish, to be fixed to the wall.

Mobile contenitore composto da due moduli in legno laccato con elementi decorativi in paglia di Vienna. I moduli sono sospesi grazie alla struttura in metallo, con finitura in ottone satinato, da fissare a parete.

Schrank bestehend aus zwei Modulen aus lackiertem Holz mit dekorativen Elementen aus Wiener Geflecht. Die Module sind dank der an der Wand zu befestigenden Metallstruktur mit satinierendem Messing-Ausführung aufgehängt.

Meuble de rangement composé de deux modules en bois laqué avec éléments décoratifs en paille de Vienne. Les modules sont suspendus grâce à la structure métallique, finition laiton satiné, à fixer au mur.



FINISHES:
C01, D29, D23

MCNNYCS1
Dimensions mm.
H 750 | W 900 | D 450

NYNY SIDEBOARD

Storage unit made up of six modules in lacquered wood with decorative elements in woven cane. The modules are suspended thanks to the metal structure, with satin brass finish, to be fixed to the wall.

Mobile contenitore composto da sei moduli in legno laccato con elementi decorativi in paglia di Vienna. I moduli sono sospesi grazie alla struttura in metallo, con finitura in ottone satinato, da fissare a parete.

Schrank bestehend aus sechs Modulen aus lackiertem Holz mit dekorativen Elementen aus Wiener Geflecht. Die Module sind dank der an der Wand zu befestigenden Metallstruktur mit satinierendem Messing-Ausführung aufgehängt.

Meuble de rangement composé de six modules en bois laqué avec éléments décoratifs en paille de Vienne. Les modules sont suspendus grâce à la structure métallique, finition laiton satiné, à fixer au mur.



FINISHES:
C01, D29, D23

MCNNYC31
Dimensions mm.
H 750 | W 2710 | D 450

NYNY UNIT

Storage unit made up of four overlapping modules in lacquered wood with decorative elements in woven cane. The modules are suspended thanks to the metal structure, with satin brass finish, to be fixed to the wall.

Mobile contenitore composto da quattro moduli sovrapposti in legno laccato con elementi decorativi in paglia di Vienna. I moduli sono sospesi grazie alla struttura in metallo, con finitura in ottone satinato, da fissare a parete.

Schrank bestehend aus vier überlappenden Modulen aus lackiertem Holz mit dekorativen Elementen aus Wiener Geflecht. Die Module sind dank der an der Wand zu befestigenden Metallstruktur mit satinierendem Messing-Ausführung aufgehängt.

Meuble de rangement composé de quatre modules superposés en bois laqué avec éléments décoratifs en paille de Vienne. Les modules sont suspendus grâce à la structure métallique, finition laiton satiné, à fixer au mur.



FINISHES:
C01, D29, D23

MCNNYTM1
Dimensions mm.
H 2000 | W 1650 | D 450

HEADBOARDS

Upon request it is available the bed base with removable fabric and wooden slats, dimensions mm H 320 | W 1600 | D 2000

OTTOW

Headboard with bent beech-wood and woven cane decoration. Central element in perforated wood. Brass details in the black lacquered version. Copper details in the natural stained version.

Testiera con struttura in faggio curvato e decoro in paglia di Vienna. Elemento centrale in legno traforato. Dettagli in ottone nella versione laccata nera e in rame in quella tinta naturale.

Kopfteilstruktur aus Buchenbugholz und Dekoration aus Wiener Geflecht. Zentralelement in perforiertem Holz. Messingdetails in schwarz lackierter Ausführung. Kupferdetails in Natur gebeizter Ausführung.

Tête de lit avec structure en hêtre cintré et décor en paille de Vienne. Élément central en bois perforé. Détails en laiton dans la version laquée noire et en cuivre dans la version teintée naturelle.



FINISHES:
B01, C01

HBOTTOPGL
Dimensions mm.
H 1300 | W 2420 | D 72

RUE

Headboard with bent beech-wood and woven cane decoration. Central element in woven cane or upholstered with removable cover. The cover in leather is not removable.

Testiera con struttura in faggio curvato e decoro in paglia di Vienna. Elemento centrale in paglia di Vienna o con imbottitura sfoderabile. Il rivestimento in pelle non è sfoderabile.

Kopfteilstruktur aus Buchenbugholz und Dekoration aus Wiener Geflecht. Zentralelement aus Wiener Geflecht oder mit abnehmbarem Bezug. Der Bezug aus Leder ist nicht abnehmbar.

Tête de lit avec structure en hêtre cintré et décor en paille de Vienne. Élément central en paille de Vienne ou rembourré déhoussable. Le rembourrage en cuir n'est pas déhoussable.



FINISHES:
B01, C01, D03

HBRUEGTES
Dimensions mm.
H 730 | W 2500 | D 150

HBRUEGPGL
Dimensions mm.
H 730 | W 2500 | D 150

YVETTE

Headboard with bent beech-wood and metal tubular frame. Woven cane decoration. Upholstered central element with removable cover. The cover in leather is not removable.

Testiera con struttura in faggio curvato e tubolare metallico, decoro in paglia di Vienna. Elemento centrale con imbottitura sfoderabile. Il rivestimento in pelle non è sfoderabile.

Kopfteilstruktur aus Buchenbugholz und Metallrohr, Dekoration mit Wiener Geflecht. Gepolstertes Zentralelement mit abnehmbarem Bezug. Der Bezug aus Leder ist nicht abnehmbar.

Tête de lit avec structure en hêtre cintré et tubulaire en métal, décor en paille de Vienne. Élément central rembourré déhoussable. Le rembourrage en cuir n'est pas déhoussable.

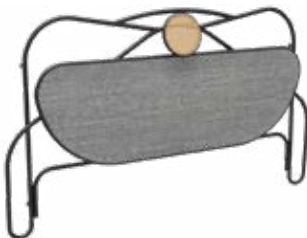

FINISHES:
B03, C01

HBVETTES
Dimensions mm.
H 1210 | W 2100 | D 110

ARCH DINING TABLE

Table with bent beech-wood frame and open pore painted ash-wood veneer top. Available in two sizes.

Tisch mit Gestell aus Buchenbugholz und Tischplatte aus offenporig lackierter furnierter Esche. In zwei Größen verfügbar.

Tavolo con struttura in faggio curvato e piano impiallacciato in frassino verniciato a poro aperto. Disponibile in due dimensioni.

Table avec structure en hêtre cintré et plateau en plaqué frêne verni à pores ouverts. Disponible en deux dimensions.

FINISHES:

TWO TONE | VERSION 1:
Ash-Wood Top: C01
Beech-Wood Legs: B03
Beech-Wood Arches: C01

TWO TONE | VERSION 2:
Ash-Wood Top: C02
Beech-Wood Legs: B01
Beech-Wood Arches: C02

TWO TONE | VERSION 3:
Ash-Wood Top: B07
Beech-Wood Legs: B01
Beech-Wood Arches: B07

ONE TONE:
Ash-Wood Top And Beech-Wood Frame:
B03, B04, Classic, Contemporary



TVDT22LGN
Dimensions mm.
H 740 | W 2200 | D 1000



TVDT18LGN
Dimensions mm.
H 740 | W 1800 | D 1000

CARYLLON DINING TABLES

Round or rectangular table with bent beech-wood structure and inlaid wooden or lacquered top .

Runder oder rechteckiger Tisch mit Struktur aus Buchenbugholz und Platte aus hölzernen Einlegearbeiten oder lackiert.

Tavolo rotondo o rettangolare con struttura in faggio curvato e piano in legno intarsiato o laccato.

Table rectangulaire ou ronde, avec structure en hêtre cintré et plateau en bois incrusté ou laqué.

FINISHES:

CARYLLON DINING TABLE - Rectangular with inlaid top (TVCARDLGN)

A. C01 (base) + bolivar (top)

B. D14 (base) + red caleidolegno (top)

CARYLLON DINING TABLE - Rectangular and two-tone lacquered (TVCARDLG2)

A. C01 (base) + D03 (top)

B. D12 (base) + D11 (top)

C. D03 (base) + D27 (top)

CARYLLON DINING TABLE- Rectangular and one-tone lacquered (TVCARDLG2)

Classic, Contemporary

CARYLLON DINING TABLE - Round with inlaid top (TVCAROLGN)

A. D25 (base) + blue caleidolegno (top)

CARYLLON DINING TABLE - Round and two-tone lacquered (TVCAROLG2)

A. C01 (base) + D03 (top)

B. D12 (base) + D11 (top)

C. D03 (base) + D27 (top)

CARYLLON DINING TABLE - Round and one-tone lacquered (TVCAROLG2)

Classic, Contemporary



TVCARDLGN
Dimensions mm.
H 760 | W 2200 | D 1100

TVCAROLGN
Dimensions mm.
H 760 | W 1600 | D 1600

TVCARDLG2
With lacquered top

TVCAROLG2
With lacquered top

TABLES

MAGISTRETTI 0302

Table with bent beech-wood frame.
Extra clear transparent glass top.

Tisch mit Gestell aus Buchenbugholz.
Tischplatte aus transparentem,
extra-klarem Glas.

Tavolo con struttura in faggio cur-
vato. Piano in vetro trasparente
extra chiaro.

Table avec structure en hêtre
cintré. Plateau en verre transparent
extra-clair.



FINISHES:
BASE: B01, B03, B04, B08, Classic, Contemporary
TOP: Extra Clear Glass

TMAGILGV
Dimensions mm.
H 740 | W 1200 | D 1200

REHBEINTISCH

Beech-wood table with bent wood
frame and scratch-resistant beech-
wood veneer top with solid wood
border. Available in 3 sizes.

Tisch mit Gestell aus Buchenbugholz.
Kratzfeste Tischplatte aus furnierter
Buchenholz mit Einfassung aus
Massivholz. In 3 Größen verfügbar.

Tavolo in faggio con struttura in
legno curvato e piano impiallacciato
in faggio verniciato antigraffio con
bordatura in massello. Disponibile
in 3 dimensioni.

Table en hêtre avec structure en
bois cintré et plateau en bois plaqué
inrayable avec bord en bois plein.
Disponible en 3 dimensions.



FINISHES:
B01, B03, B04, B08, Classic, Contemporary,

TVRH31LGN
Dimensions mm.
H 740 | W 700 | D 700

TVRH41LGN
Dimensions mm.
H 740 | W 900 | D 900

TVRH42LGN
Dimensions mm.
H 740 | W 1200 | D 1200

RING DINING TABLE

Table with bent beech-wood frame
and beech-wood veneer top.

Tisch mit Gestell aus Buchenbugholz
und Tischplatte aus furnierter Buche.

Tavolo con struttura in faggio cur-
vato e piano impiallacciato in faggio.

Table avec structure en hêtre cintré
et plateau en hêtre plaqué.



FINISHES:
B01, B03, B04, B08 Classic, Contemporary

TVRINDLGN
Dimensions mm.
H 750 | W 2100 | D 900

TABLES

SÄULE

Table with canaletto walnut veneer structure and solid canaletto walnut legs. Glossy laminate top.

Tisch mit Struktur aus Canaletto Walnussfurnier und Beinen aus massivem Canaletto Walnuss. Platte aus glänzendem Laminat.

Tavolo con struttura in impiallacciato noce canaletto e gambe in massello noce canaletto. Top in laminato lucido.

Table avec structure en placage de noyer canaletto et pieds en noyer canaletto massif. Plateau en stratifié brillant



FINISHES:
Base: B06
Top: 891 scotch brown / plum red / dark chocolate

TVSA22LGN
Dimensions mm.
H 750 | W 2200 | D 900

TVSA41LGN
Dimensions mm.
H 750 | W 3000 | D 1000

BRANDY

Bar table available in two heights with metal round base and post, in polished copper or polished brass finishes. Round top in marble, laminate or natural/stained oak veneer, also available with edge ring in a finish to match the base.

Kaffeetisch in zwei verschiedenen Höhen mit runder Basis und Fuss aus Metall, Kupfer oder Messing poliert. Runde Tischplatte aus Marmor, Laminat oder furniert Eiche Natur/gebeizt, auch verfügbar mit gleicher Umrandung wie Basis.

Tavolo da bar disponibile in due altezze con base rotonda e stelo in metallo, nelle finiture rame lucido o ottone lucido. Top rotondo in marmo, laminato o impiallacciato rovere naturale o tinto, disponibile anche con ghiera perimetrale in finitura coordinata alla base.

Table de bar disponible en deux hauteurs avec base ronde et pied central en métal, pour les finitions en cuivre poli ou laiton poli. Plateau rond en marbre, recouvert de laminé ou plaqué chêne naturel ou teinté, également disponible avec un rebord périmétral en finition coordonnée à la base.



TABRANBAR
Dimensions mm.
H 1140 | W 700 | D 700
with marble top
H 1120 | W 700 | D 700

TBRRANBAR
Dimensions mm.
H 760 | W 700 | D 700
with marble top
H 740 | W 700 | D 700

COGNAC

Bar table available in two heights with round metal base in bronze, copper or brass finishes. Post in stained or painted solid wood or in black epoxy powder painted metal. Round top in marble, laminate or natural/stained oak veneer, also available with edge ring in a finish to match the base.

Kaffeetisch in zwei verschiedenen Höhen mit runder Metallbasis in Bronze, Kupfer oder Messing. Fuß aus gebeiztem oder lackiertem Massivholz oder aus Schwarz pulverbeschichtetem Metall. Runde Tischplatte aus Marmor, Laminat oder furniert Eiche Natur/gebeizt, auch verfügbar mit gleicher Umrandung wie Basis.

Tavolo da bar disponibile in due altezze con base rotonda in metallo nelle finiture bronzo, rame, ottone. Stelo in massello di legno tinto, laccato o in metallo verniciato nero a polvere epossidica. Top rotondo in marmo, laminato o impiallacciato rovere naturale o tinto, disponibile anche con ghiera perimetrale in finitura coordinata alla base.

Table de bar disponible en deux hauteurs avec base ronde en métal pour les finitions en bronze, cuivre ou laiton. Pied central en bois massif teinté, laqué ou en métal peint en noir en poudre. Plateau rond en marbre, recouvert de laminé ou plaqué chêne naturel ou teinté, également disponible avec un rebord périmétral en finition coordonnée à la base.



TACOGNBAR
Dimensions mm.
H 1140 | W 700 | D 700
with marble top
H 1120 | W 700 | D 700

TBCOGNBAR
Dimensions mm.
H 760 | W 700 | D 700
with marble top
H 740 | W 700 | D 700

TABLES

PASTIS

Bar table with square post, top and base. In black painted metal or with bronze finish. Top covered in laminate or natural/ stained oak veneer, also available with an edge ring with bronze finish.

Tavolo da bar con montante, piano e base quadrati. In metallo verniciato nero o con finitura bronzata. Top rivestito in laminato o impiallacciato rovere naturale o tinto, disponibile anche con ghiera perimetrale in finitura bronzata.

Kaffeetisch mit quadratischem Pfeiler, Fuß und quadratischer Tischplatte. Aus Schwarz lackiertem Metall oder in bronzefarbener Ausführung. Platte überzogen mit Laminat oder furniert Eiche Natur/gebeizt, auch verfügbar mit bronzefarbener Umrandung.

Table de bar avec pied central, base et plateau carrés. En métal peint en noir ou avec finition bronzée. Plateau recouvert de laminé ou plaqué chêne naturel ou teinté, également disponible avec un rebord périmétral en finition bronzée.



TVPASTBAR
Dimensions mm.
H 760 | W 700 | D 700

PORTO

Bar table with round post, top and base. In black painted metal or with bronze finish. Top covered in laminate or natural/ stained oak veneer, also available with an edge ring with bronze finish.

Tavolo da bar con montante, piano e base rotondi. In metallo verniciato nero o con finitura bronzata. Top rivestito in laminato o impiallacciato rovere naturale o tinto, disponibile anche con ghiera perimetrale in finitura bronzata.

Kaffeetisch mit rundem Pfeiler, Fuß und runder Tischplatte. Aus schwarz lackiertem Metall oder in bronzefarbener Ausführung. Platte überzogen mit Laminat oder furniert Eiche Natur/ gebeizt, auch verfügbar mit bronzefarbener Umrandung.

Table de bar avec pied central, base et plateau ronds. En métal peint en noir ou avec finition bronzée. Plateau recouvert de laminé ou plaqué chêne naturel ou teinté, également disponible avec un rebord périmétral en finition bronzée.



TVPORTBAR
Dimensions mm.
H 760 | W 700 | D 700

RUM

Bar table available in two heights with metal square base and post, in polished copper or polished brass finishes. Square top in marble, laminate or natural/ stained oak veneer, also available with edge ring in a finish to match the base.

Tavolo da bar disponibile in due altezze con base quadrata e stelo in metallo, nelle finiture rame lucido o ottone lucido. Top quadrato in marmo, laminato o impiallacciato rovere naturale o tinto, disponibile anche con ghiera perimetrale in finitura coordinata alla base.

Kaffeetisch in zwei verschiedenen Höhen mit quadratischer Basis und Fuss aus Metall, Kupfer oder Messing poliert. Quadratische Tischplatte aus Marmor, Laminat oder furniert Eiche Natur/gebeizt, auch verfügbar mit gleicher Umrandung wie Basis.

Table de bar disponible en deux hauteurs avec base carrée et pied central en métal, pour les finitions en cuivre poli ou laiton poli. Plateau carré en marbre, recouvert de laminé ou plaqué chêne naturel ou teinté, également disponible avec un rebord périmétral en finition coordonnée à la base.



TARUMMBAR
Dimensions mm.
H 1140 | W 700 | D 700
with marble top
H 1120 | W 700 | D 700



TBRUMMBAR
Dimensions mm.
H 760 | W 700 | D 700
with marble top
H 740 | W 700 | D 700

TABLES

SHERRY

Bar table available in two heights with square metal base in bronze, copper or brass finishes. Post in stained or painted solid wood or in black epoxy powder painted metal. Square top in marble, laminate or natural/stained oak veneer, also available with edge ring in a finish to match the base.

Kaffeetisch in zwei verschiedenen Höhen mit quadratischer Metallbasis in Bronze, Kupfer oder Messing. Fuß aus gebeiztem oder lackiertem Massivholz oder aus schwarz pulverbeschichtetem Metall. Quadratische Tischplatte aus Marmor, Laminat oder furniert Eiche Natur/gebeizt, auch verfügbar mit gleicher Umrandung wie Basis.

Tavolo da bar disponibile in due altezze con base quadrata in metallo nelle finiture bronzo, rame, ottone. Stelo in massello di legno tinto, laccato o in metallo verniciato nero a polvere epossidica. Top quadrato in marmo, laminato o impiallacciato rovere naturale o tinto, disponibile anche con ghiera perimetrale in finitura coordinata alla base.

Table de bar disponible en deux hauteurs avec base carrée en métal pour les finitions en bronze, cuivre ou laiton. Pied central en bois massif teinté, laqué ou en métal peint en noir en poudre. Plateau carré en marbre, recouvert de laminé ou plaqué chêne naturel ou teinté, également disponible avec un rebord périmétral en finition coordonnée à la base.



TASHERBAR
Dimensions mm.
H 1140 | W 700 | D 700
with marble top
H 1120 | W 700 | D 700

TBSHERBAR
Dimensions mm.
H 760 | W 700 | D 700
with marble top
H 740 | W 700 | D 700

VERMOUTH

Bar table in cast iron painted black. Round or square top covered in laminate or natural/stained oak veneer.

Kaffeetisch mit gusseiserner Struktur, schwarz lackiert. Runde oder quadratische Tischplatte überzogen mit Laminat oder furniert Eiche Natur/gebeizt.

Tavolo da bar con struttura in fusione di ghisa verniciata nera. Top rotondo o quadrato rivestito in laminato o impiallacciato rovere naturale o tinto.

Table de bar avec structure en fusion de fonte peinte en noir. Plateau rond ou carré recouvert de laminé ou plaque chêne naturel ou teinté.



TWERMBAR
Dimensions mm.
H 760 | W 700 | D 700

TABLES

ARCH COFFEE TABLE

Bent beech-wood coffee table. Beech-wood veneer or "stopsol" glass top.

Kleiner Couchtisch aus Buchenbugholz. Tischplatte aus furnierter Buchenholz oder „Stopsol“- Glas.

Tavolino in faggio curvato. Piano disponibile in faggio impiallacciato o in vetro "stopsol".

Table basse en hêtre cintré. Plateau disponible en hêtre plaqué ou en verre "stopsol".



FINISHES:
WOODEN TOP: B01, B03, B04, B08, Classic, Contemporary
STOPSOL GLASS TOP: Classic

TVCOFFLGV
Dimensions mm.
H 460 | W 730 | D 730

TVCOFFLGN
Dimensions mm.
H 460 | W 730 | D 730

CARYLLON LOW TABLES

Flower shaped coffee table with lacquered bent beech-wood structure and inlaid wooden top. Available in two heights.

Blumenförmiger Kaffeetisch mit Struktur aus lackiertem Buchenbugholz und Platte aus hölzernen Einlegearbeiten. In zwei Höhen erhältlich.

Tavolino a forma di fiore con struttura in faggio curvato laccato e piano in legno intarsiato. Disponibile in due altezze.

Table basse en forme de fleur avec structure en hêtre cintré laqué et plateau en bois incrusté. Disponible en deux hauteurs.



FINISHES:
BASE: C01 / TOP: PAMA
BASE: D21 / TOP: SYCOMORE FRISE'

TACARCLGN
Dimensions mm.
H 450 | W 1200 | D 1200

TBCARCLGN
Dimensions mm.
H 250 | W 1200 | D 1200

DUET

Coffee table collection with structure in brass-plated steel and bent beech-wood with square sections. Top in black tinted glass or "Emperador Brown" marble. Available in three sizes.

Kleine Tischkollektion mit Messing plattiertem Stahl- und Buchenbugholzgestell mit quadratischem Querschnitt. Tischplatte aus rauch-schwarzem Glas oder "Emperador Brown" Marmor. Erhältlich in drei Größen.

Collezione di tavolini con struttura in acciaio ottonato e faggio curvato a sezione quadrata. Piano in vetro nero fumé o marmo "Emperador Brown". Disponibili in tre dimensioni.

Collection de tables basses avec structure en acier plaqué laiton et hêtre cintré à section carré. Plateau en verre noir fumé ou en marbre "Emperador Brown". Disponible en trois tailles.



FINISHES:
BASE: C01
TOP: Black Tinted Glass Or Marble

TVDUEALGV
Dimensions mm.
H 500 | W 450 | D 500

TVDUEBLGM
Dimensions mm.
H 350 | W 700 | D 550

TVDUECLGM
Dimensions mm.
H 300 | W 900 | D 700

HOLD ON SIDE TABLE

Folding coffee table with ash wood frame and "stopsol" glass or "Emperador Brown" marble.

Kleiner Klapptisch mit Gestell aus Eschenholz und Tischplatte aus „Stopsol“-Glas oder „Emperador Brown“-Marmor.

Tavolino pieghevole con struttura in frassino e piano in vetro "stopsol" o in marmo "Emperador Brown".

Table basse pliante avec structure en frêne et plateau en verre «stopsol» ou en marbre «Emperador Brown».



FINISHES:
BASE: B03, B04, B07
TOP: Glass, Marble

TVHOLDLGM
Dimensions mm.
H 520 | W 540 | D 540

MOS SIDE TABLE

Side table with bent beech-wood frame and woven cane inserts. Open pore painted shelves in ash veneer. Brass feet.

Beistelltisch mit Buchenbugholzgestell und eingesetztem Wiener Geflecht. Regale aus offenporigem, lackiertem Eschefurnier. Messing-Füßen.

Tavolino con struttura in faggio curvato e inserti in paglia di Vienna. Ripiani impiallacciati in frassino verniciato a poro aperto. Puntali in ottone.

Table basse avec structure en hêtre cintré et inserts en paille de Vienne. Étagères en plaqué frêne teinté à pores ouverts. Pieds en laiton.



FINISHES:
B01, B07, C01

TBMOSGLGP
Dimensions mm.
H 450 | W 500 | D 470 | SHH 150

PEERS

Bent beech-wood coffee tables. Laminated top.

Kleine Beistelltische aus Buchenbugholz. Tischplatte aus Laminat.

Tavolini in faggio curvato. Piano in laminato

Tables basses en hêtre cintré. Plateau laminé.



FINISHES:
BASE A/B – C01
PEER A (TVPEEALGN): HPL_Blu notte 1861 / HPL_Agave 1947
PEER B (TVPEEBLGN): HPL_Terra d'ombra 893 / HPL_Tuareg 1942

TVPEEBLGN
Dimensions mm.
H 420 | W 740 | D 630

TVPEEALGN
Dimensions mm.
H 420 | W 930 | D 630

TABLES

SINGLE CURVE LOW TABLES

Coffee table collection with bent beech-wood frame. Top available in glass, marble, or matt lacquered.

Kleine Tischkollektion mit Gestell aus Buchenbugholz. Tischplatten aus Glas, Marmor, oder matt lackierten Platten.

Collezione di tavolini con struttura in faggio curvato. Piano disponibile in vetro, in marmo, oppure laccato opaco.

Collection de tables basses avec structure en hêtre cintré. Plateau disponible en verre, en marbre, ou bien en laqué mat.



FINISHES:
BASE: B01, C01
TOP: Glass, Marble, Classic or Contemporary wood

TVNLOCLGV
Dimensions mm.
H 300 | W 800 | D 800

TVNLOBLGM
Dimensions mm.
H 350 | W 600 | D 600

TVNLOALGN
Dimensions mm.
H 500 | W 450 | D 450

WIENER BOX

Collection of low tables with brass-finished metal frames. Top and base in lacquered black mat wood. Woven cane side panels with solid beech frame. Available in two sizes.

Kleine Tischkollektion mit einer Metallstruktur mit Messing Finish. Oberteil und Fuß aus mattschwarz lackiertem Buchenholz. Seitenteile aus Wiener Geflecht mit massivem Buchenholzrahmen. In zwei Größen erhältlich.

Collezione di tavolini con struttura in metallo finitura ottone. Top e base in legno laccato nero opaco. Pannelli laterali in paglia di Vienna con cornice in massello di faggio. Disponibili in due dimensioni.

Collection de tables basses avec structure en métal finition laiton. Plateau et base en bois laqué noir mat. Panneaux latéraux en paille de Vienne avec cadre en hêtre massif. Disponible en deux dimensions.



FINISHES:
C01

TVBOXALGN
Dimensions mm.
H 510 | W 570 | D 500

TVBOXBLGN
Dimensions mm.
H 330 | W 1070 | D 500

ALLEGORY DESK

Desk with bent beech-wood frame and open pore painted ash-wood veneer top. Also available with drawer. Woven cane circular decorative element.

Schreibtisch mit Gestell aus Buchenbugholz, Tischplatte aus offenporig lackierter furnierter Esche und rundem Dekoelement aus Wiener Geflecht. Auch verfügbare mit Schublade.

Scrivitoio con struttura in faggio curvato e piano impiallacciato in frassino verniciato a poro aperto, disponibile anche con cassetto. Elemento decorativo circolare in paglia di Vienna.

Bureau avec structure en hêtre cintré et plateau en plaqué frêne teinté à pores ouverts. Disponible aussi avec tiroir. Élément décoratif circulaire en paille de Vienne.



FINISHES:
ASH-WOOD TOP: B07, Classic
BEECH WOOD FRAME: B01, Classic

DKALECPGL
Dimensions mm.
H 1260 | W 1000 | D 660 | TH 750

DKALEGPGL
Dimensions mm.
H 1260 | W 1000 | D 660 | TH 750

ARCH CLOTHES VALET

Two-tone bent beech-wood clothes valet: black and natural beech.

Stummer Diener aus zweifarbigem Buchenbugholz: in Schwarz und Buche Natur.

Servo muto in faggio curvato bicolore: nero e faggio naturale.

Valet en hêtre cintré bicolore: noir et hêtre naturel.



FINISHES:
B01-C01 / C01-B01

CHVALELGN
Dimensions mm.
H 1070 | W 460 | D 260

CLOUD

Bent beech-wood umbrella stand, available in lacquered with natural beech feet. Transparent neutral receptacle.

Schirmständer aus Buchenbugholz. Lackiert mit Füße in Buche Natur verfügbar. Schale neutral-durchsichtig.

Portaombrelli in faggio curvato; disponibile laccato con gambaleto in faggio naturale. Vaschetta colore neutro trasparente.

Porte-parapluies en hêtre cintré; disponible en laqué avec les pieds en hêtre naturel. Récipient couleur neutre transparent.



FINISHES:
Classic and Natural Legs

OMCLOULGN
Dimensions mm.
H 740 | W 406 | D 406

EYESHINE MIRRORS

Bent ash-wood mirrors available in three versions. Each version is available in two sizes.

Spiegel aus Eschenbugholz in drei Versionen erhältlich. Jede Version ist in zwei Größen erhältlich.

Specchi in frassino curvato disponibili in tre versioni. Ogni versione è disponibile in due dimensioni.

Miroirs en frêne cintré disponibles en trois versions. Chaque version est disponible en deux dimensions.



FINISHES:
B07, Classic, D03, D28

SHEYESCC1
Dimensions mm.
H 640 | W 640 | D 40

SHEYESCO1
Dimensions mm.
H 640 | W 640 | D 40

SHEYESOC1
Dimensions mm.
H 560 | W 730 | D 40

SHEYESCC2
Dimensions mm.
H 320 | W 320 | D 20

SHEYESCO2
Dimensions mm.
H 320 | W 320 | D 20

SHEYESOC2
Dimensions mm.
H 280 | W 360 | D 20

FENG

Modular folding screen with bent beech-wood frame and fabric partition panels stretched over metal frame. Brass details. Available in selected fabrics with 2 or 3 panels.

Paravent mit gebogenem Buchenholzrahmen und Trennwänden aus gespanntem Gewebe auf Metallrahmen. Details aus Messing. Erhältlich in ausgewählten Stoffe mit 2 oder 3 Stoffbahnen

Paravento con struttura in faggio curvato e pannelli divisori in tessuto teso su struttura di metallo. Dettagli in ottone. Disponibile in tessuti selezionati con 2 o 3 pannelli.

Paravent modulaire avec structure en hêtre cintré et panneaux diviseurs en tissu tendu sur cadre métallique. Détails en laiton. Disponible en tissus sélectionné avec 2 ou 3 panneaux.

FINISHES:
B01, C01

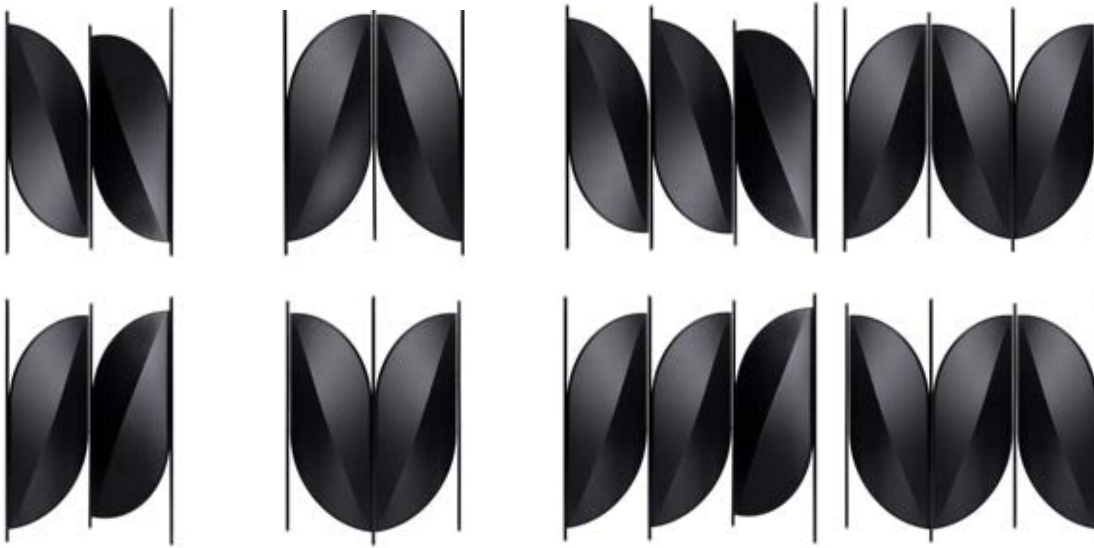

PRFEN2TES/1
Dimensions mm.
H 1940 | W 1400 | D 200

PRFEN2TES/2
Dimensions mm.
H 1940 | W 1400 | D 200

PRFEN3TES/1
Dimensions mm.
H 1940 | W 2320 | D 200

PRFEN3TES/2
Dimensions mm.
H 1940 | W 2320 | D 200

FURIA

Rocking horse with bent beech-wood frame. Seat and details available in leather only.

Cavallino a dondolo con struttura in faggio curvato. Seduta e dettagli disponibili solo in pelle.

Schaukelpferd mit Gestell aus Buchenbugholz. Sitz und Details nur aus Leder.

Petit cheval à bascule avec structure en hêtre cintré. Assise et détails disponibles uniquement en cuir souple.



FINISHES:
C01

CAFURITES
Dimensions mm.
H 690 | W 520 | D 710 | SH 450

KLEIDERSTÄNDER

Bent beech-wood coat stand.

Appendiabiti in faggio curvato.

Kleiderständer aus Buchenbugholz.

Porte-manteaux en hêtre cintré.



FINISHES:
B01, B03, B04, B08, Classic, Contemporary

AP2204LGN
Dimensions mm.
H 1850 | W 520 | D 520

KLEIDERSTÄNDER P. 29

Bent beech-wood coat stand.

Appendiabiti in faggio curvato.

Kleiderständer aus Buchenbugholz.

Porte-manteaux en hêtre cintré.



FINISHES:
B01, B03, B04, B08, Classic, Contemporary

APKL19LGN
Dimensions mm.
H 1820 | W 620 | D 620

KOLO MOSER

Bent beech-wood coat stand.

Appendiabiti in faggio curvato.

Kleiderständer aus Buchenbugholz.

Porte-manteaux en hêtre cintré.



FINISHES:
Classic

APKOL0LGN
Dimensions mm.
H 1950 | W 700 | D 700

LADDER

Bent ash-wood decorative element, useful as a clothes valet. Available in 3 sizes.

Elemento decorativo in frassino curvato, con funzione di servomuto. Disponibile in 3 dimensioni.

Dekoratives Element aus Eschenbugholz, ideal als Stummer Diener. In 3 Größen verfügbar.

Élément décoratif en frêne cintré avec fonction de valet. Disponible en 3 dimensions.



FINISHES:
B07, Classic

CML250LGN
Dimensions mm.
H 2570 | W 450 | D 36

CML200LGN
Dimensions mm.
H 2055 | W 450 | D 36

CML160LGN
Dimensions mm.
H 1540 | W 450 | D 36

MAJORDOMO

Square-section beech-wood clothes valet with woven cane seat and shelf.

Servomuto in faggio a sezione quadrata con seduta e piano d'appoggio in paglia di Vienna.

Stummer Diener aus Buche mit quadratischem Querschnitt mit Sitzfläche und Abdeckplatte aus Wiener Geflecht.

Valet en hêtre à section carrée avec assise et plan d'appui en paille de Vienne.



FINISHES:
B01, Classic

CAMAJOPGL
Dimensions mm.
H 900 | W 610 | D 610 | SH 450 | AH 680

STOCKSSEL

A folding seat and walking cane combined. Woven cane seat.

Sgabello pieghevole e bastone da passeggio combinato. Sedile in paglia di Vienna.

Spazierstock und Klapphocker in einem. Sitz aus Wiener Geflecht.

Tabouret pliant et canne combinée. Assise en paille de Vienne.



FINISHES:
B01, B03, B04, B08, Classic, Contemporary

BSSTOKLGN
Dimensions mm.
H 640 | W 230 | D 440 | SH 540

WAGASA

Suspended and floor lamp with Carrara marble base and pole in black lacquered beech wood. Fabric lampshade with woven cane trim. Parchment light diffuser in the suspended version.

Lampada a sospensione e da terra con basamento in marmo Carrara e stelo in legno di faggio laccato nero. Paralume in tessuto con inserti in paglia di Vienna. Diffusore di luce in pergamena solo nella versione a sospensione.

Pendelleuchte und Stehlampe mit Sockel aus Carrara-Marmor und Stiel aus schwarz lackierter Buche. Lampenschirm aus Gewebe mit Umrandung aus Wiener Geflecht. Pergament-Lichtdiffusor nur in der Pendelversion.

Lampe à suspension et de plancher avec la base en marbre de Carrare et le tige en bois de hêtre laqué noir. Abat-jour en tissu avec bordure en paille de Vienne. Diffuseur de lumière en parchemin uniquement dans la version à suspension.



FINISHES:
POLE: C01
LAMP SHADE: Kwadrat Reflex 449 / Kwadrat Fuse 631 / Kwadrat Fuse 351
Kwadrat Fuse 981 / Kwadrat Reflex 159

LPWAGATES
Dimensions mm.
H 1720 | W 650 | D 650

LSWAGATES
Dimensions mm.
H 500 | W 650 | D 650

WALTZ

Modular wall-mounted bent ash-wood coat rack with one brass hook included. Additional hooks are sold separately.

Appendiabiti modulare da parete in frassino curvato con un gancio in ottone incluso. Ganci supplementari venduti separatamente.

Modular aufgebaute Wandgarderobe aus Eschenbugholz, mit einem Messinghaken enthalten. Zusätzliche Haken sind separat erhältlich.

Porte-manteaux modulable mural en frêne cintré avec un crochet en laiton inclus. Crochets supplémentaires vendus séparément.

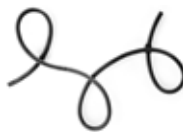

FINISHES:
B07, Classic

CHWALZLGN
Dimensions mm.
H 540 | W 930 | D 70

AROUND COLORS RUGS COLLECTION

Hand-tufted rugs in wool and viscose. Available in 4 shapes and colors.

Handgefertigte Teppiche aus Wolle und Viskose. Erhältlich in 4 Formen und Farben.

Tappeti taftati a mano in lana e viscosa. Disponibili in 4 forme e colori.

Tapis tuftés à la main en laine et viscose. Disponible en 4 formes et couleurs.



YELLOW
TPACOLTA1
Dimensions mm.
W 3000 | D 1900

PINK
TPACOLTA2
Dimensions mm.
W 3000 | D 2300

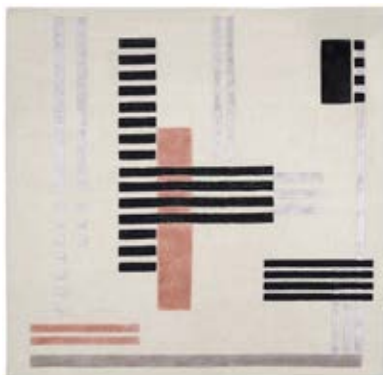

GREY
TPACOLTA3
Dimensions mm.
W 2500 | D 2500

BROWN
TPACOLTA4
Dimensions mm.
W 2600 | D 1600

CURVED CUSHIONS COLLECTION

Square-shaped cushions in Kvadrat HERO fabric filled with goose feather or polyester fibre. Decorative motifs inspired by some of the company's iconic products (N.1 / Loos Café Museum / Targa / Sugiloo / NYNY). Available in 4 different colours (black, yellow, orange and green).

Quadratische Kissen aus Kvadrat HERO-Stoff, gefüllt mit Gänsefedern oder Polyesterfasern. Dekorative Motive, inspiriert von einigen der ikonischen Produkte des Unternehmens (N.1 / Loos Café Museum / Targa / Sugiloo / NYNY). Erhältlich in 4 verschiedenen Farben (schwarz, gelb, orange und grün).

Cuscini quadrati in panno di lana (Kvadrat Hero). Imbottitura in piume d'oca o fibre di poliestere. Decorati con motivi ispirati ad alcune icone dell'azienda (N.1 / Loos Café Museum / Targa / Sugiloo / NYNY). Disponibili in 4 varianti di colore (nero, giallo, arancione e verde).

Coussins de forme carrée en tissu Kvadrat HERO, remplis de plumes d'oie ou de fibres de polyester. Motifs décoratifs inspirés de certains des produits emblématiques de l'entreprise (N.1 / Musée du Café Loos / Targa / Sugiloo / NYNY). Disponible en 4 couleurs différentes (noir, jaune, orange et vert).

FINISHES:
black, yellow, orange, green



N.1 STYLE
PWCCNITES
Dimensions mm.
H 450 | W 450 | D 200



N.1 STYLE
PWCCNITES
Dimensions mm.
H 450 | W 450 | D 200



N.1 STYLE
PWCCNITES
Dimensions mm.
H 450 | W 450 | D 200



N.1 STYLE
PWCCNITES
Dimensions mm.
H 450 | W 450 | D 200



LOOS CAFÉ MUSEUM STYLE
PWCCLOTES
Dimensions mm.
H 450 | W 450 | D 200



LOOS CAFÉ MUSEUM STYLE
PWCCLOTES
Dimensions mm.
H 450 | W 450 | D 200



LOOS CAFÉ MUSEUM STYLE
PWCCLOTES
Dimensions mm.
H 450 | W 450 | D 200



LOOS CAFÉ MUSEUM STYLE
PWCCLOTES
Dimensions mm.
H 450 | W 450 | D 200



TARGA STYLE
PWCCSTATES
Dimensions mm.
H 450 | W 450 | D 200



TARGA STYLE
PWCCSTATES
Dimensions mm.
H 450 | W 450 | D 200



TARGA STYLE
PWCCSTATES
Dimensions mm.
H 450 | W 450 | D 200



TARGA STYLE
PWCCSTATES
Dimensions mm.
H 450 | W 450 | D 200



NYNY STYLE
PWCCNYTES
Dimensions mm.
H 450 | W 450 | D 200



NYNY STYLE
PWCCNYTES
Dimensions mm.
H 450 | W 450 | D 200



NYNY STYLE
PWCCNYTES
Dimensions mm.
H 450 | W 450 | D 200



NYNY STYLE
PWCCNYTES
Dimensions mm.
H 450 | W 450 | D 200



SUGILOO STYLE
PWCCSUTES
Dimensions mm.
H 450 | W 450 | D 200



SUGILOO STYLE
PWCCSUTES
Dimensions mm.
H 450 | W 450 | D 200



SUGILOO STYLE
PWCCSUTES
Dimensions mm.
H 450 | W 450 | D 200



SUGILOO STYLE
PWCCSUTES
Dimensions mm.
H 450 | W 450 | D 200

INDEX OF FABRICS SHOWN IN THE PICTURES

Beaulieu

p. 36 Kvadrat Remix 3 col. 762
p. 37, 41, 233 Kvadrat Remix 3 col. 912
p. 37, 232 Kvadrat Remix 3 col. 516
p. 38, 231 Kvadrat Remix 3 col. 536

Bistrotstuhl

p. 42 Kvadrat Divina 3 col. 956
Kvadrat Divina 3 col. 876
Kvadrat Divina 3 col. 936
p. 43 Kvadrat Fuse col. 351

Bodystuhl

p. 46, 230, 281 Kvadrat Fuse 121
p. 47 Dedar Adamo ed Eva col. 109 anice

Brezel

p. 48 Discontinued fabric
p. 49 Discontinued fabric

Caféstuhl

p. 51 Kvadrat Fuse col. 981

Coat Rack Bench

p. 118 Kvadrat Coda 2 col. 116

Chignon

p. 132, 133, 134 Kvadrat Steelcut Trio 3 col. 124
p. 135 Eisenstadt A05 004

Czech

p. 56, 57 Loro Piana Zelandier Check col. 205

Feng

p. 258, 259, 260, 261 Kvadrat Campas 300 col. 104

Gustav

p. 61 Kvadrat Divina 3 col. 584

Hideout

p. 136, 137 Steyr B08 005
p. 138 Kvadrat Twill Weave col. 990
p. 139 Discontinued fabric
p. 285 Kvadrat Coda 2 col. 100

Hold on

p. 140 Kvadrat Divina MD col. 213
p. 141 Liezen A04 020

Jannis Sofa

Pag. 142, 143, 144, 145, 184: Discontinued fabric
Pag. 146, 147, 149: Kvadrat Steelcut Trio 3 col. 133

Jannis Lounge

Pag. 147, 148, 190, 191: Kvadrat Steelcut Trio 3 col. 153

Lehnstuhl

p. 150 Steyr B08 005
p. 152 Kvadrat Divina 3 col. 742

Loie

p. 157 Kvadrat Twill Weave col. 570
p. 158, 159 Loro Piana Altai Unito col. 39 Zenzero
p. 181 Kvadrat Raas col. 942

p. 218 Discontinued fabric
p. 219 Kvadrat Raas col. 942

Loos Cafè Museum

p. 63 Discontinued fabric

Magistretti 0301

p. 64 Cuoio/Leather C01 002

Malit

p. 66, 211 Kvadrat Divina MD col. 213
p. 67 Discontinued fabric
p. 215 Kvadrat Divina 3 col. 191
p. 238 Discontinued fabric

Mos

p. 188, 189, 204 Discontinued fabric
p. 161 Loro Piana Connemara col. 14 Cowes

Morris

p. 68 Discontinued fabric
p. 69 Kvadrat Divina 3 col. 154
p. 222, 223 Kvadrat Hallingdal 65 col. 723

N.0

p. 70 Steyr B08 015
p. 71 Hallein A06 007
p. 72 Steyr B08 005

N.14

p. 76 Steyr B08 018

N.18

p. 78 Discontinued fabric

N.200

p. 161, 162 Loro Piana Connemara col. 14 Cowes

N.811

p. 81, 240 Eisenstadt A05 002
p. 82 Steyr B08-015

N.811 Barstool

p. 83 Eisenstadt A05 010
p. 83 Eisenstadt A05 002

Pince

p. 84, 85 Kvadrat Hallingdal 65 col. 166

Post Mundus

p. 86 Kvadrat Harald 3, col. 192
p. 87 Discontinued fabric

Postsparkasse

p. 88 Dedar Adamo ed Eva col. 117 Opera

Promenade Sofa

p. 164, 165, 166, 244 Steyr B08 016

Promenade Lounge

p. 167 Dedar Adamo ed Eva Anice 109

Radetzky

p.94 Kvadrat Hallingdal 65 col. 723

Rue

p. 204, 206 Loro Piana Connemara col. 10 Malachite

Ruhering

p. 117 Steyr B08 013

Sölden

p. 96, 97, 99 Kvadrat Merit col. 007
p. 98 Kvadrat Divina 3 col. 462
p. 100, 101, 237 Steyr B08 018

Sugiloo

p. 102 Kvadrat Rass 142
p. 103, 106, 220, 235 Discontinued fabric

Suzenne Lounge

p. 170, 171 Discontinued fabric
p. 172 Kvadrat Coda 2 col. 232
p. 174, 175, 194, 197 Discontinued fabric
p. 279 Discontinued fabric

Suzenne Sofa

p. 173 Discontinued fabric
p. 174, 175 Discontinued fabric
p. 278 Kvadrat Fuse 121

Targa Lounge

p. 177 Kvadrat Divina 3 col. 584
p. 178 Kvadrat Divina 3 col. 856
p. 179 Steyr B08 004

Targa Pouf

p. 139 Discontinued fabric
p. 176, 177 Kvadrat Divina 3 col. 584
p. 180 Kvadrat Steelcut Trio 3 col. 124

Targa Sofa

p. 160 Kvadrat Remix 3 col. 123
p. 176, 177 Discontinued fabric
p. 178 Kvadrat Divina 3 col. 856
p. 252, 253 Kvadrat Raas col. 182
p. 282, 283 Kvadrat San col. 750

Targa Modular

p. 180, 181 Kvadrat Steelcut Trio 3 col. 124

Trio

p. 129 Steyr B08 005

Vienna 144 Barhocker and Hocker

p. 130 Discontinued fabric
p. 131, 232 Kvadrat Remix 3 col. 912
p. 131 Remix 3 col. 516

Wiener stuhl

p. 112 Kvadrat Coda 2 col. 100
p. 113, 228 Camira Parson MLF14
p. 210 Liezen A04 025

Yvette

p. 208, 209 Discontinued fabric

Art Direction:

R+W

Graphic Project:

Country Lab | Gianfranco Martorella

Project Coordination:

Caterina Moiso
Giulia Cabrini

Photo:

Gionata Xerra Studio
Neferstudio
Paolo Meitre Libertini
Tullio Deorsola
Margherita Borsano

Concept e styling:

Simona Silenzi Studio

Ha collaborato:

Gaia Marchesini, Giordano Sarno

Photo assistant:

Leonardo Duggento
Marco Manigrasso

Post produzione immagini:

Pierpaolo Mazzola

Credits:

PALAZZO MADAMA
Museo Civico d'arte antica, Torino.
on kind concession from
Fondazione Torino Musei.
*It is forbidden to further reproduce
or duplicate by any means.*

PALAZZO REALE
Thanks to Palazzo Reale and
Caffetteria Reale Di Torino,
on kind concession
from Ministero dei Beni e delle
Attività Culturali e del Turismo,
Direzione Regionale per i Beni
culturali e paesaggistici
del Piemonte.

Thanks to
TEATRO REGIO TORINO
for the cooperation.

The Manufacturer reserves the right to modify products and accessories at any time without prior notice.

Die Firma behält sich vor, Produkte und Zubehör unabhängig vom Zeitpunkt und ohne jede Voranmeldung zu ändern.

L'azienda si riserva il diritto in qualunque momento di apportare senza preavviso modifiche a prodotti e accessori.

L'entreprise se réserve de modifier les articles et les accessoires en chaque moment et sans préavis.

L'azienda si dichiara disponibile a riconoscere eventuali diritti per il materiale iconografico di cui non sia stato possibile individuare la fonte.

The manufacturer declares to be available to recognize possible rights for iconographic material, whose origin was not possible to be traced back.

Thanks to:

Alice in Wonderland - Studio Marcante Testa (UdA)
Bottega Baretti - www.bottegabaretti.com
Caffè dei fratelli Fiorio
Caffè Mulassano
Casa Fulvia Moscheni - Fabio Fantolino Architetto
Casa Sette - Fabio Fantolino Architetto
Copernico Torino www.coperni.co
Dash Kitchen (To), Dopolavoro Bicocca Milano
Duparc Contemporary Suites
Fabio Fantolino, architetto
Grattacielo Intesa Sanpaolo
Il Deposito Bistrot
Lo Stonnato www.stonnato.it
Nh Collection Piazza Carlina
Notaio Giuseppe Volpe & Associati - Studio Marcante Testa (UdA)
Ristorante Il Bastimento

Agape
Applicata
Astep
Am Living Studio
Amini
Another Country
Artemide
AYTM
Bitossi Home
Bloc Studios
Bosa Trade
Brionvega
Budri Italian Marble Inlay - Ad Group
Fragile Milano
Carpet Edition
CC Tapis
Danese
Davide Aquini
Flos
Fondaco
FontanaArte
FPM Milano
Francesca Verardo Ceramics
Galleria Nicola Quadri
Golran
Galleria Salvatore Lateri
Il Coccio design edition
Ilaria Innocenti
Interno Italiano
Kanz Architetti
Knindustrie Presso Agape12 - Milano
Kristina Dam
Kundalini
Lindell&Co
Littala
Louise Poulsen
Luceplan
Mani ceramiche
Martina Geroni
Meyers & Fügmann
MM Lampadari
Mmairo
Nahoor Limelight
Nemo Cassina
Nilufar Gallery
Nodus
Nude Glass
Nuoveforme
Oeuffice Design Studio
Oluce
Once Milano
Palorosa
Paola C
Pulpo
Pasabahce (Garbo)
Penta Light
Raawii
Sambonet
Santa & Cole
Scandola Marmi
Schola Testori
Society
Stilnovo
Stip
Stories of Italy
Tine K Home
Vanessa Mitrani
Zanellato Bortotto

Gebrüder Thonet Vienna GmbH
Prinz Eugen Straße 42 - 1040 Wien, (AT)
www.gebruederthonetvienna.com

Offices of the trademarks' licensee
Production Furniture International S.p.A.
Via Foggia, 23/H - 10152 Torino (TO) Italy
Phone: 0039 011 0133330
info@gebruederthonetvienna.com

Print: AGT s.r.l. (TO) 07/2021

When printing on paper, the shades of the colours of various materials cannot be faithfully reproduced. Therefore it must only be considered indicative and cannot constitute a reason for dispute or for the return of the product.

Bei Papierdruck können die Farbtöne der verschiedenen Materialien nicht originalgetreu wiedergegeben werden. Bei den Abbildungen sind daher Abweichungen möglich, die kein Recht auf Beanstandungen oder Rückgabe des Produkts begründen.

Nella stampa su carta, la tonalità dei colori dei vari materiali non può essere riprodotta fedelmente. Pertanto deve considerarsi indicativa e non potrà costituire motivo di contestazione o di resa del prodotto.

Lors de l'impression sur papier, la tonalité des couleurs des différents matériaux ne peut pas être parfaitement reproduite. Les couleurs ne sont donc qu'indicatives et ne pourront pas constituer un motif de contestation ou de retour du produit.

Printed on Fedrigoni X-per White and Symbol Freelifa E/E Raster



