

# GALAXIA



<b>ASTRO</b>	4	CARBON
	8	STARWHITE
	12	TIMBER
	16	TITANIUM

<b>DUAL</b>	22	"V" CARBON
	24	"V" STARWHITE
	26	"V" TIMBER
	30	"T" CARBON
	32	"T" STARWHITE
	34	"T" TIMBER

<b>QUATTRO</b>	38	CARBON
	40	STARWHITE
	42	TIMBER

46	<b>BALLAST</b>
48	<b>GROUND FIXING</b>
50	<b>OPTIONAL BASE</b>
52	<b>FABRIC COLLECTION</b>
56	<b>KIT LED GALAXIA</b>
58	<b>MATERIALI E FINITURE / MATERIALS AND FINISHING</b>
59	<b>ACCESSORIES</b>



I

Abbiamo ideato un nuovo futuro per vivere lo spazio esterno dominato da sinergia tra:

- Tecnologia
- Ergonomia
- Design
- Innovazione

La sapienza e l'eccellenza italiana artigiana si sono evolute e raffinate attraverso studi accurati e dedicati, tecnologici e di ingegneria, ottenendo risultati STRATOSFERICI: GALAXIA.

EN

We have created a futuristic way of living the outdoors through the synergic combination of:

- Technology
- Ergonomics
- Design
- Innovation

Italian wisdom and artisanal excellence have evolved and been refined through dedicated technological and engineering studies, producing stratospheric results: GALAXIA.

D

Futuristisch innovative Art im Freien zu leben Synergie zwischen:

- Technologie
- Ergonomie
- Design
- Innovation

Die Weisheit und die handwerkliche italienische Exzellenz haben sich weiterentwickelt und verfeinert durch genaue, relevante, technologische und technische Forschungen. Es wurden stratosphärische Ergebnisse erzielt: GALAXIA.

F

Nous avons créé un nouveau produit reposant sur un nouveau concept , la synergie entre :

- Technologie
- Ergonomie
- Conception
- Innovation

L'excellence et le raffinement de l'artisanat italien ont évolué grâce à des études précises et des avancées technologiques de l'ingénierie , permettant d'obtenir des résultats exceptionnels: GALAXIA.

E

Hemos ideado un nuevo futuro para vivir el espacio exterior en sinergia dominado entre:

- Tecnología
- Ergonomía
- Diseño
- Innovación

La sabiduría y la excelencia italiana artesana se han evolucionado y perfeccionado a través de estudios cuidadosos y dedicados, tecnológicos y de ingeniería, obteniendo resultados ESTRATOSFÉRICOS: GALAXIA.

## MOTION



I

**SISTEMA "MOTION"**  
Alla base del funzionamento innovativo c'è il Sistema Motion, che evolve il concetto di apertura e chiusura retrattile dell'ombrellone. In questa applicazione innovativa i bracci a forbice azionano direttamente le corone centrali per l'apertura e la chiusura.

EN

**SYSTEM "MOTION"**  
The revolutionary MOTION system allows the umbrella to open and retract in one motion. The innovative scissor arms activate the central crowns which in turn open and close the umbrella.

D

**SYSTEM "MOTION"**  
An der Basis des innovativen Betriebs befindet sich das System Motion, dass das Konzept der Öffnung und Schließung des einziehbaren Schirmes entwickelt. In dieser innovativen Anwendung setzen die scherenförmige Arme direkt die zentralen Kronen zum Öffnen und Schließen in Bewegung.

F

**SYSTEM "MOTION"**  
A la base de l'opération novatrice il y a le système Motion, qui évolue le concept d'ouverture et de fermeture du parasol rétractable. Dans cette innovante les bras à ciseaux operant directement sur les couronnes centrales pour l'ouverture et la fermeture.

E

**SISTEMA "MOTION"**  
A la base de la operación innovadora está el sistema de movimiento, que evoluciona el concepto de abrir y cerrar el parasol retráctil. En esta aplicación innovadora, los brazos de tijeras conducen directamente las coronas centrales por apertura y cierre.

## LIFT ACTION



## ERGONOMY DESIGN



I

### LIFT ACTION

La principale innovazione è l'applicazione di una molla a gas che agisce sul sistema MOTION assistendo l'apertura e riducendo al minimo lo sforzo in fase di apertura e chiusura dell'ombrellone.

### ERGONOMY DESIGN

Non solo tecnologia e funzionalità, ma anche ergonomia nei movimenti. Il design e il gusto italiano incidono sapientemente e rendono questo ombrellone unico in ogni singola linea trasmettendo sensazioni di equilibrio nelle forme.

EN

### LIFT ACTION

The main innovation is in the hydraulic gas strut which activates the MOTION system, assisting the mechanical operation and minimizing the effort required to open and close the umbrella.

### ERGONOMY DESIGN

Technology, functionality and ergonomic movements. Italian design and style make this umbrella unique, giving a sense of balance to its modern shape.

D

### LIFT ACTION

Die wichtigste Neuerung ist die Anwendung einer Gasdruckfeder, die auf das System Motion wirkt und eine mühelose Öffnung und Schließung des Schirmes ermöglicht.

### ERGONOMY DESIGN

Nicht nur Technik und Funktionalität, sondern auch Ergonomie der Bewegung. Das Design und das italienische Design haben einen grossen Einfluss und machen aus diesem Schirm ein einzigartiges Produkt. Jede einzelne Linie uebermittelt Gleichgewicht.

F

### LIFT ACTION

La principale innovation est la présence d'un ressort à gaz agissant sur le fonctionnement du parasol en facilitant l'ouverture et en réduisant l'effort d'ouverture et de fermeture du parasol.

### ERGONOMY DESIGN

Non seulement la technologie et la fonctionnalité, mais aussi l'ergonomie du mouvement. La conception et l'influence de style italien à bon escient et de faire ce parasol unique dans chaque ligne, transmettant des sentiments d'équilibre dans les formes.

E

### LIFT ACTION

La principal innovación es la aplicación de un muelle de gas que actúa sobre el sistema de movimiento por ayudar a la apertura y reducir al mínimo el esfuerzo en la apertura y cierre del parasol.

### ERGONOMY DESIGN

No sólo la tecnología y funcionalidad, sino también ergonomía de movimiento. El diseño y la influencia de estilo italiano inciden sabiamente y hacen este parasol único en cada línea, transmitiendo la sensación de equilibrio en las formas.



scolaro



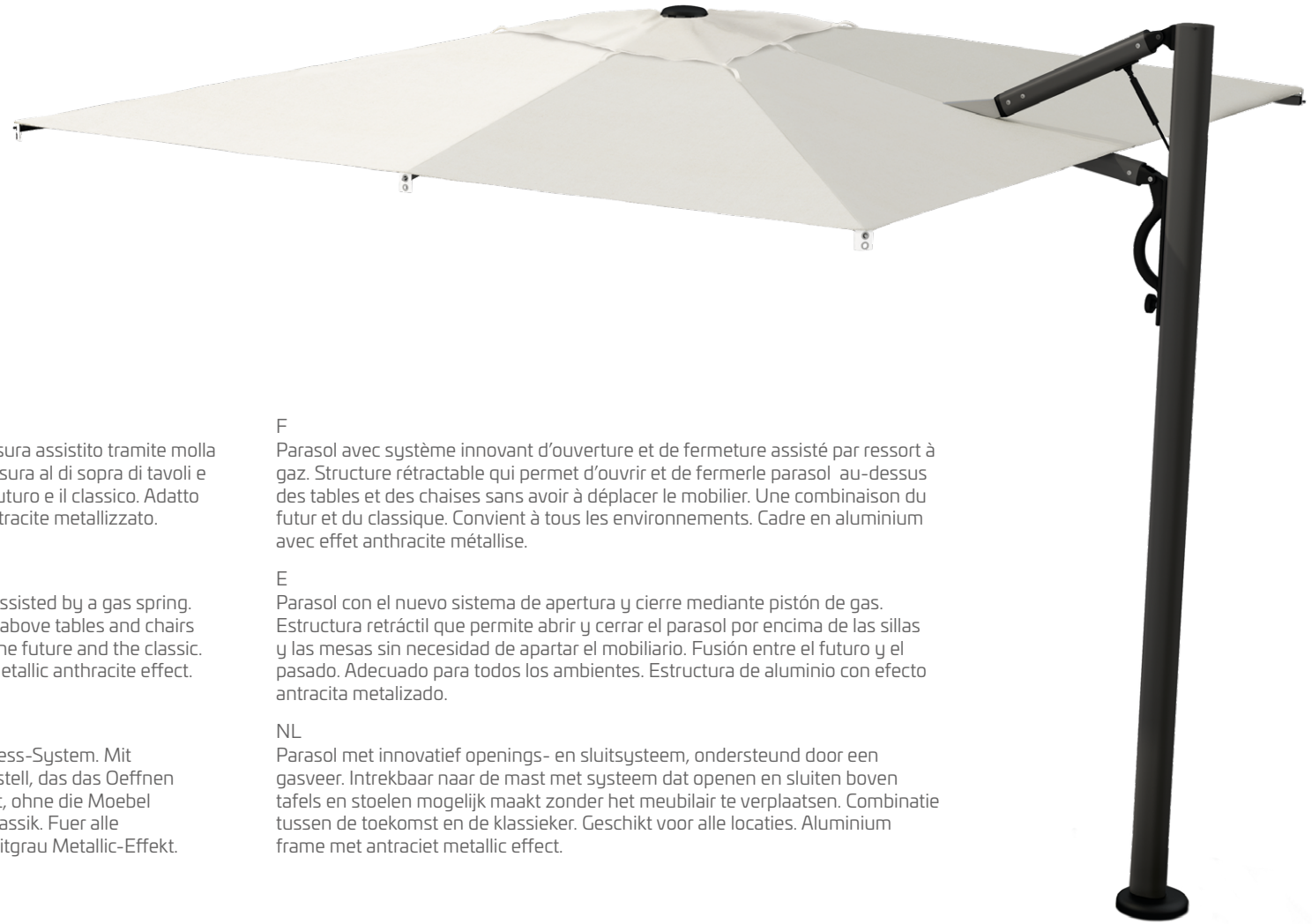

# Astro Carbon

I  
Ombrellone con innovativo sistema di apertura e chiusura assistito tramite molla a gas. Struttura retrattile che permette apertura e chiusura al di sopra di tavoli e sedie senza dover spostare gli arredi. Connubio tra il futuro e il classico. Adatto per tutti gli ambienti. Telaio in alluminio con effetto antracite metallizzato.



EN  
Parasol with innovative opening and closing system assisted by a gas spring. Retractable structure that allows opening and closing above tables and chairs without moving the furniture. Combination between the future and the classic. Suitable for all environments. Aluminum frame with metallic anthracite effect.

D  
Sonnenschirm mit innovativem Öffnungs- und Schliess-System. Mit Unterstützung durch eine Gasfeder einziehbares Gestell, das das Öffnen und Schliessen ueber Tische Und Stuehle ermoeglicht, ohne die Moebel umzuraeumen Kombination zwischen Zukunft und Klassik. Fuer alle Umgebungen geeignet. Aluminiumgestell mit anthrazitgrau Metallic-Effekt.

F  
Parasol avec système innovant d'ouverture et de fermeture assisté par ressort à gaz. Structure rétractable qui permet d'ouvrir et de fermerle parasol au-dessus des tables et des chaises sans avoir à déplacer le mobilier. Une combinaison du futur et du classique. Convient à tous les environnements. Cadre en aluminium avec effet anthracite métallise.

E  
Parasol con el nuevo sistema de apertura y cierre mediante pistón de gas. Estructura retráctil que permite abrir y cerrar el parasol por encima de las sillas y las mesas sin necesidad de apartar el mobiliario. Fusión entre el futuro y el pasado. Adecuado para todos los ambientes. Estructura de aluminio con efecto antracita metalizado.

NL  
Parasol met innovatief openings- en sluitsysteem, ondersteund door een gasveer. Intrekbaar naar de mast met systeem dat openen en sluiten boven tafels en stoelen mogelijk maakt zonder het meubilair te verplaatsen. Combinatie tussen de toekomst en de klassieker. Geschikt voor alle locaties. Aluminium frame met antraciet metallic effect.

	
300x300 350x350	300x400











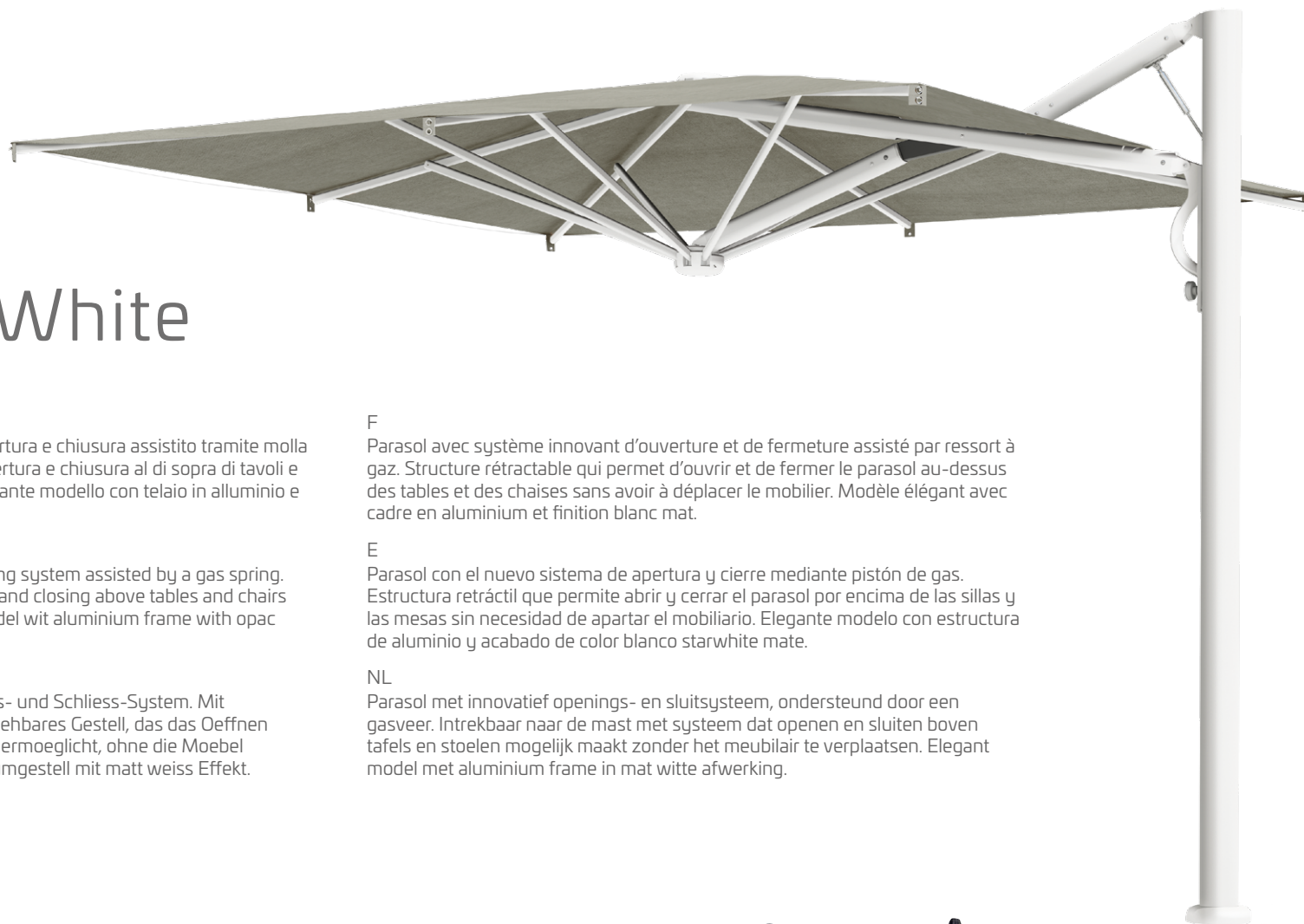

# Astro StarWhite

I  
Ombrellone con innovativo sistema di apertura e chiusura assistito tramite molla a gas. Struttura retrattile che permette apertura e chiusura al di sopra di tavoli e sedie senza dover spostare gli arredi. Elegante modello con telaio in alluminio e finitura colore bianco starwhite opaco.

EN  
Parasol with innovative opening and closing system assisted by a gas spring. Retractable structure that allows opening and closing above tables and chairs without moving the furniture. Elegant model with aluminium frame with opac starwhite finish.

D  
Sonnenschirm mit innovativem Öffnungs- und Schliess-System. Mit Unterstützung durch eine Gasfeder Einziehbares Gestell, das das Öffnen und Schliessen ueber Tische Und Stuehle ermöglicht, ohne die Moebel umzuraeumen Elegantes Model. Aluminiumgestell mit matt weiss Effekt.

F  
Parasol avec système innovant d'ouverture et de fermeture assisté par ressort à gaz. Structure rétractable qui permet d'ouvrir et de fermer le parasol au-dessus des tables et des chaises sans avoir à déplacer le mobilier. Modèle élégant avec cadre en aluminium et finition blanc mat.

E  
Parasol con el nuevo sistema de apertura y cierre mediante pistón de gas. Estructura retráctil que permite abrir y cerrar el parasol por encima de las sillas y las mesas sin necesidad de apartar el mobiliario. Elegante modelo con estructura de aluminio y acabado de color blanco starwhite mate.

NL  
Parasol met innovatief openings- en sluitsysteem, ondersteund door een gasveer. Intrekbaar naar de mast met systeem dat openen en sluiten boven tafels en stoelen mogelijk maakt zonder het meubilair te verplaatsen. Elegant model met aluminium frame in mat witte afwerking.

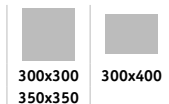







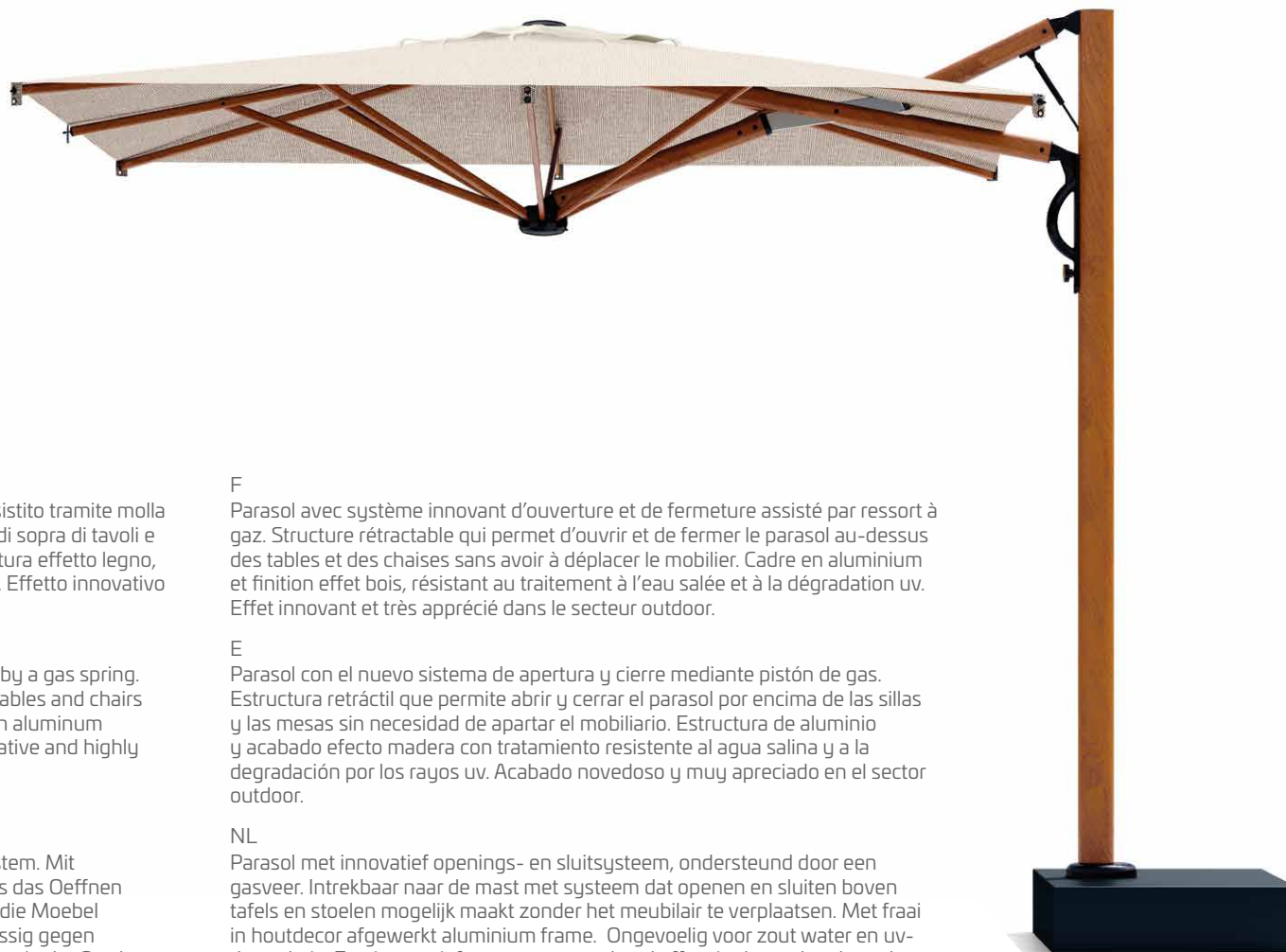

# Astro Timber

**I**  
 Ombrellone con innovativo sistema di apertura e chiusura assistito tramite molla a gas. Struttura retrattile che permette apertura e chiusura al di sopra di tavoli e sedie senza dover spostare gli arredi. Telaio in alluminio e finitura effetto legno, trattamento resistente all'acqua salata e alla degradazione uv. Effetto innovativo e molto apprezzato nel settore outdoor.



**EN**  
 Parasol with innovative opening and closing system assisted by a gas spring. Retractable structure that allows opening and closing above tables and chairs without moving the furniture. With highly durable wood finish aluminum frame. Impervious to saltwater and uv degradation. An innovative and highly appreciated effect in the outdoor branch.

**D**  
 Sonnenschirm mit innovativem Oeffnungs- und Schliess-System. Mit Unterstuetzung durch eine Gasfeder Einziehbares Gestell, das das Oeffnen Und Schliessen ueber Tische Und Stuehle ermoeglicht, ohne die Moebel umzuraeumen Aluminium Gestell mit Holzeffekt. Undurchlaessig gegen Salzwasser und Uv-Degradation Innovativ und hochgeschaetzt in der Outdoor-Branche.

**F**  
 Parasol avec système innovant d'ouverture et de fermeture assisté par ressort à gaz. Structure rétractable qui permet d'ouvrir et de fermer le parasol au-dessus des tables et des chaises sans avoir à déplacer le mobilier. Cadre en aluminium et finition effet bois, résistant au traitement à l'eau salée et à la dégradation uv. Effet innovant et très apprécié dans le secteur outdoor.

**E**  
 Parasol con el nuevo sistema de apertura y cierre mediante pistón de gas. Estructura retráctil que permite abrir y cerrar el parasol por encima de las sillas y las mesas sin necesidad de apartar el mobiliario. Estructura de aluminio y acabado efecto madera con tratamiento resistente al agua salina y a la degradación por los rayos uv. Acabado novedoso y muy apreciado en el sector outdoor.

**NL**  
 Parasol met innovatief openings- en sluitsysteem, ondersteund door een gasveer. Intrekbaar naar de mast met systeem dat openen en sluiten boven tafels en stoelen mogelijk maakt zonder het meubilair te verplaatsen. Met fraai in houtdecor afgewerkt aluminium frame. Ongevoelig voor zout water en uv-degradatie. Een innovatief en zeer gewaardeerd effect in de outdoor branche.

	
300x300	300x400
350x350	







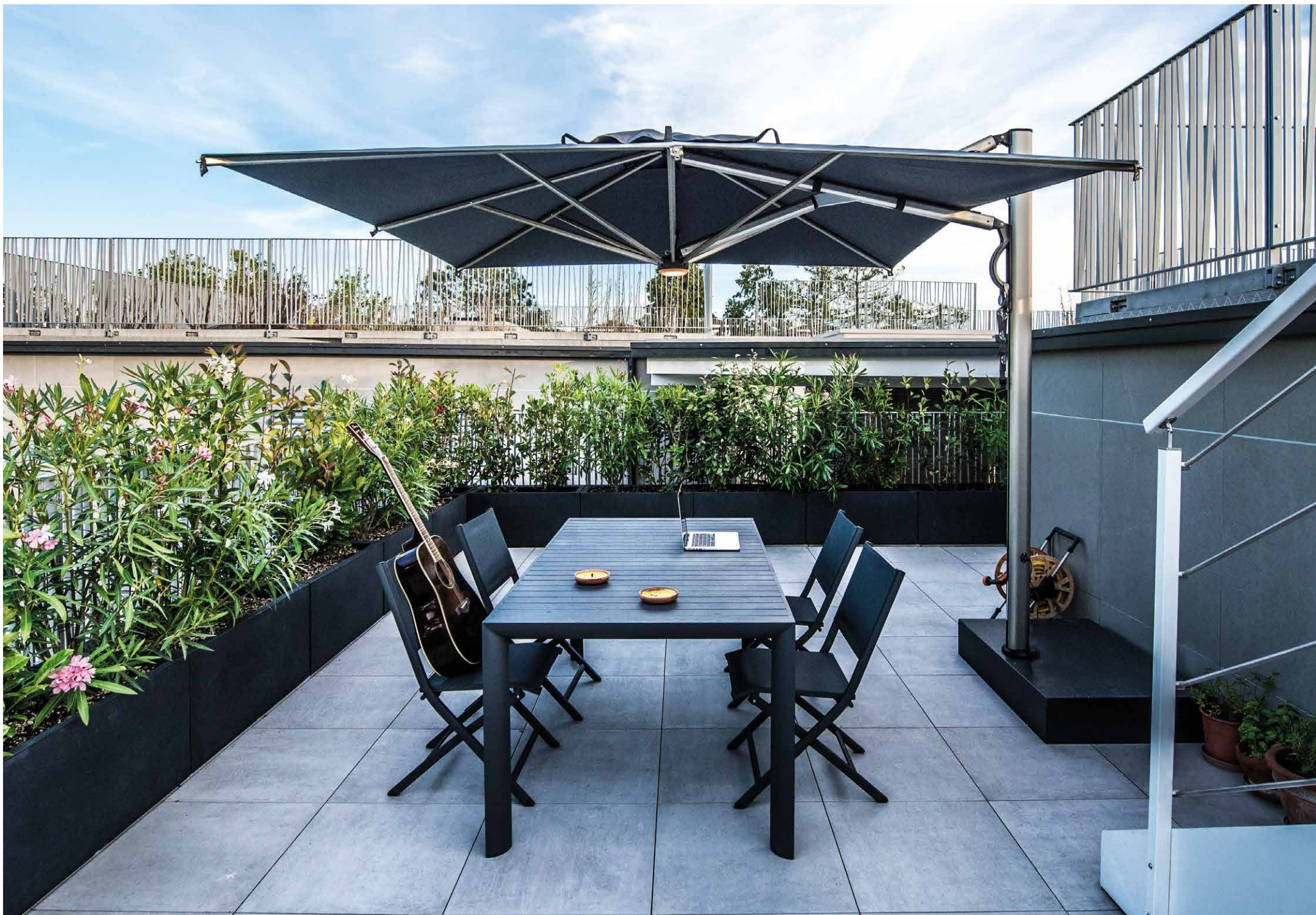



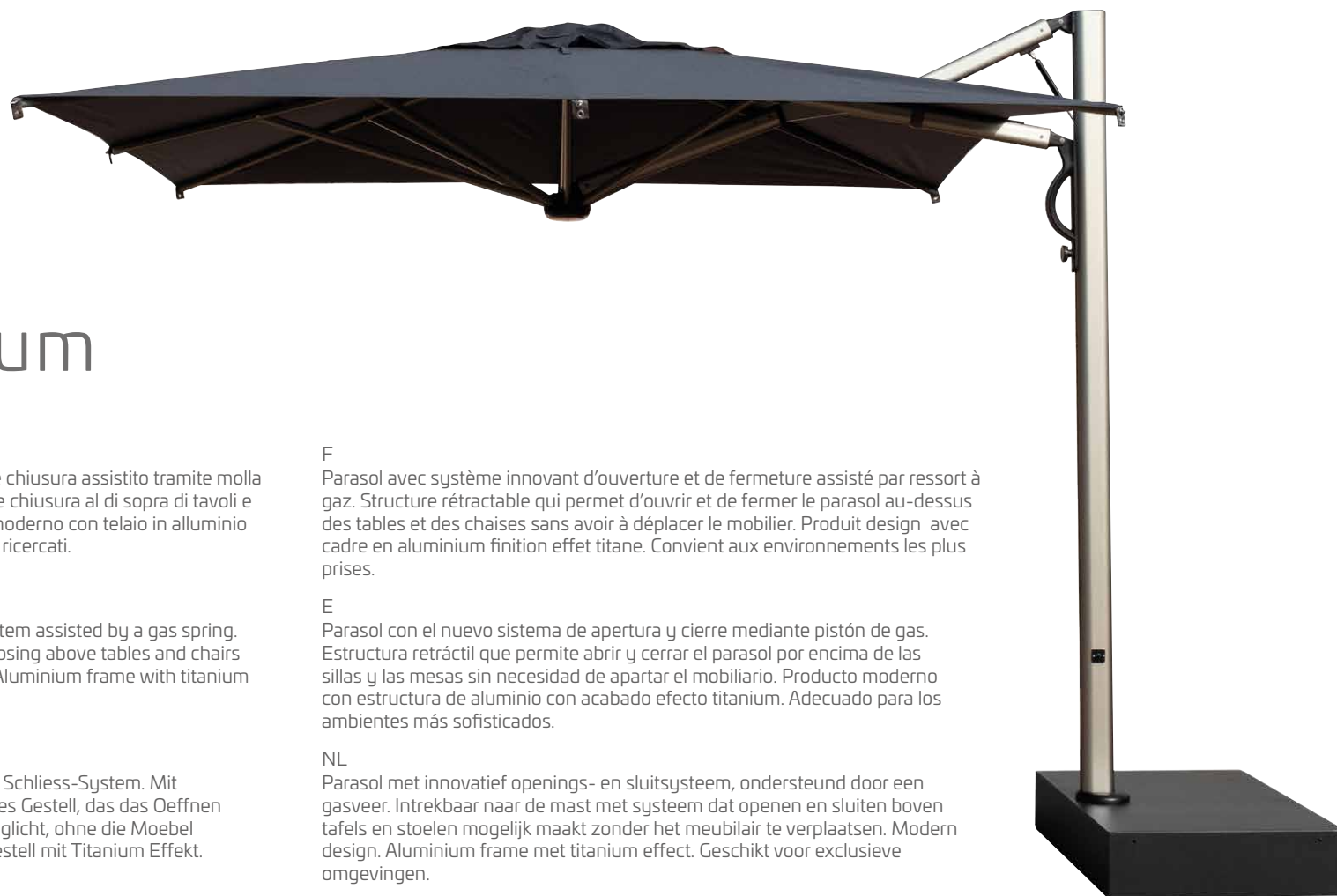

# Astro Titanium

I  
Ombrellone con innovativo sistema di apertura e chiusura assistito tramite molla a gas. Struttura retrattile che permette apertura e chiusura al di sopra di tavoli e sedie senza dover spostare gli arredi. Prodotto moderno con telaio in alluminio finitura effetto titanium. Adatto agli ambienti più ricercati.

EN  
Parasol with innovative opening and closing system assisted by a gas spring. Retractable structure that allows opening and closing above tables and chairs without moving the furniture. Modern product. Aluminium frame with titanium effect. Suitable for exclusive environments.

D  
Sonnenschirm mit innovativem Öffnungs- und Schliess-System. Mit Unterstützung durch eine Gasfeder Einziehbares Gestell, das das Öffnen und Schliessen ueber Tische und Stuehle ermöglicht, ohne die Moebel umzuraeumen Modernes Produkt. Aluminiumgestell mit Titanium Effekt. Fuer exklusive Umgebungen geeignet.

F  
Parasol avec système innovant d'ouverture et de fermeture assisté par ressort à gaz. Structure rétractable qui permet d'ouvrir et de fermer le parasol au-dessus des tables et des chaises sans avoir à déplacer le mobilier. Produit design avec cadre en aluminium finition effet titane. Convient aux environnements les plus prises.

E  
Parasol con el nuevo sistema de apertura y cierre mediante pistón de gas. Estructura retráctil que permite abrir y cerrar el parasol por encima de las sillas y las mesas sin necesidad de apartar el mobiliario. Producto moderno con estructura de aluminio con acabado efecto titanium. Adecuado para los ambientes más sofisticados.

NL  
Parasol met innovatief openings- en sluitsysteem, ondersteund door een gasveer. Intrekbaar naar de mast met systeem dat openen en sluiten boven tafels en stoelen mogelijk maakt zonder het meubilair te verplaatsen. Modern design. Aluminium frame met titanium effect. Geschikt voor exclusieve omgevingen.

300x300	300x400
350x350	





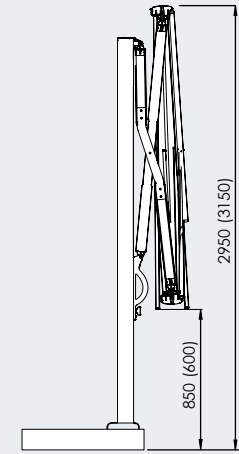
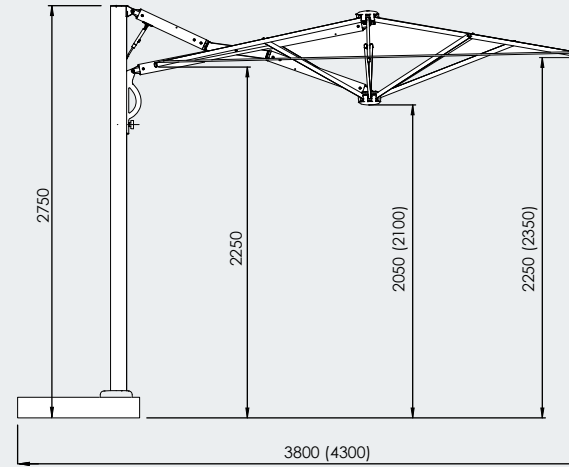
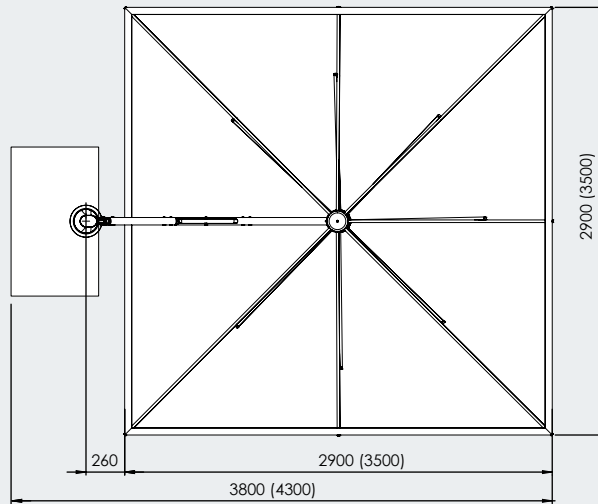

# Astro

Carbon  
StarWhite  
Timber  
Titanium

Icon	COD	KG	MP	Icon	CHARACTERISTICS				FINISHING						
					Icon	Icon	Icon	Icon	Icon	Icon	Icon	Icon	Icon	Icon	Icon
3,0x3,0	CARBON C3030 ASC	55	0,45	110x76	CARBON	8	CARBON	18x30	●	●	●	●	●	●	●
	STARWHITE C3030 ASW				STARWHITE		STARWHITE								
	TIMBER C3030 ASL				TIMBER		TIMBER								
	TITANIUM C3030 AST				TITANIUM		TITANIUM								
3,5x3,5	CARBON C3535 ASC	60	0,45	110x76	CARBON	8	CARBON	18x30	●	●	●	●	●	●	●
	STARWHITE C3535 ASW				STARWHITE		STARWHITE								
	TIMBER C3535 ASL				TIMBER		TIMBER								
	TITANIUM C3535 AST				TITANIUM		TITANIUM								
3,0x4,0	CARBON C3040 ASC	60	0,45	110x76	CARBON	8	CARBON	18x30	●	●	●	●	●	●	●
	STARWHITE C3040 ASW				STARWHITE		STARWHITE								
	TIMBER C3040 ASL				TIMBER		TIMBER								
	TITANIUM C3040 AST				TITANIUM		TITANIUM								

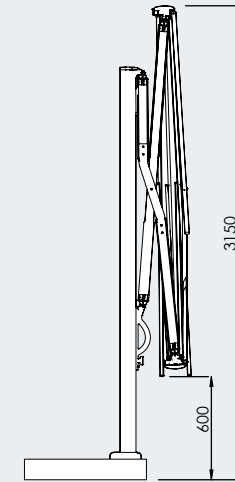
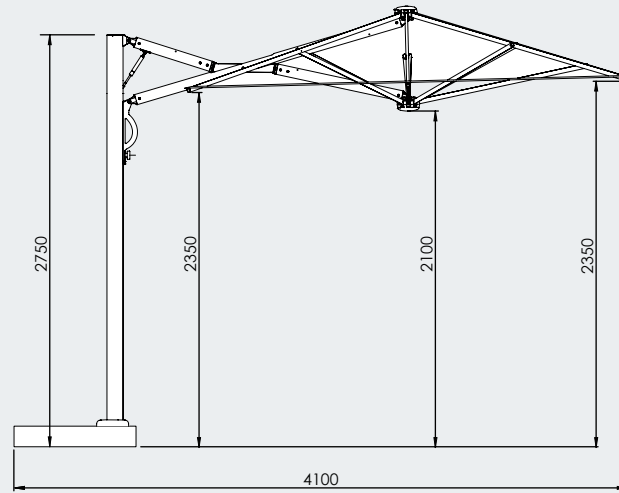
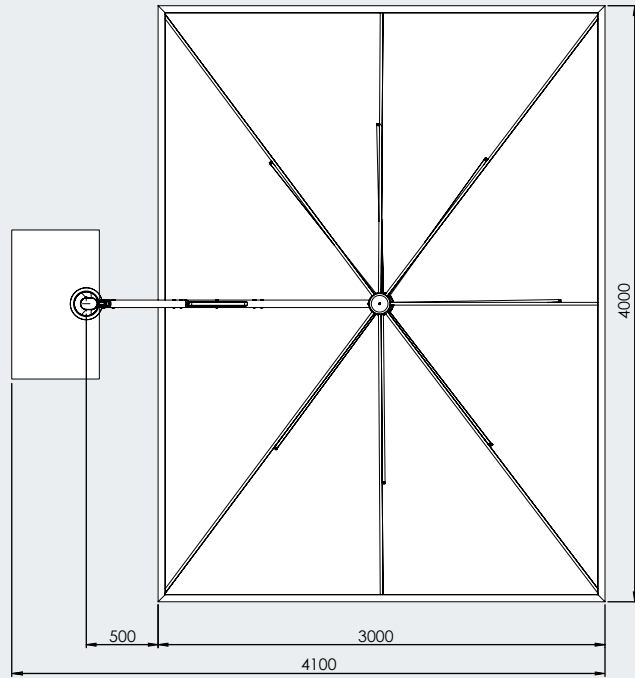

A1	T2	T3	T6	T7	T8	T9	S1		
								•	•
A1N	T2N	T3N	T6N	T7N	T8N	T9N	S1N	•	•
								•	•
A1N	T2N	T3N	T6N	T7N	T8N	T9N	S1N	•	•

**OPTIONAL**

N°4 BC5151  
N°12 BC5050

N°2 BV5050

SEE PAGE 48  
FISSAGGIO TERRA  
GROUND FIXING





# Dual "V" Carbon



I  
Evoluzione dell'ombrellone singolo astro con innovativo sistema di apertura e chiusura assistito tramite molla a gas. Struttura retrattile che permette apertura e chiusura al di sopra di tavoli e sedie senza dover spostare gli arredi. Adatto per tutti gli ambienti e consigliato per uso professionale (bar, ristoranti, hotel e dehor). Telaio in alluminio con effetto antracite metallizzato. Struttura robusta composta da 2 ombrelloni affiancati ed ancorati ad un unico sostegno.

EN  
Evolution of the single parasol astro with innovative opening and closing system assisted by a gas spring. Retractable structure that allows opening and closing above tables and chairs without moving the furniture. Suitable for all environments and recommended for a commercial employ (bars, restaurants, hotels and terrace dehors). Aluminum frame with metallic anthracite effect. Strong structure composed of 2 parasols side by side and anchored to a single support.

D  
Entwicklung des Einzelschirmes Astro mit Innovativem Oeffnungs- und Schliess-System. Mit Unterstuetzung durch eine Gasfeder Einziehbares Gestell, das das Oeffnen und Schliessen ueber Tische und Stuehle ermoeglicht, ohne die Moebel umzuraeumen Geeignet fuer alle Umgebungen und empfohlen fuer einen gewerblichen Einsatz (Bars, Restaurants, Hotels und Terrassen)  
Aluminiumgestell mit Anthrazitgrau Metallic-Effekt Starkes Gestell, bestehend aus 2 Sonnenschirmen, die nebeneinander stehen und an einem Mast verankert sind.

F  
Parasols double avec système innovant d'ouverture et de fermeture assisté par ressort à gaz. Structure rétractable qui permet d'ouvrir et de fermer les parasols au-dessus des tables et des chaises sans avoir à déplacer le mobilier. Convient à tous les environnements et recommandé pour un usage professionnel (bars, restaurants, hôtels, collectivites, chr....). Cadre en aluminium effet anthracite métalisé. Structure robuste composée de 2 parasols accroche à un seul mat.

E  
Evolución del parasol individual astro con el nuevo sistema de apertura y cierre mediante pistón de gas. Estructura retráctil que permite abrir y cerrar el parasol por encima de las sillas y las mesas sin necesidad de apartar el mobiliario. Adecuado pata todos los ambientes y recomendado para uso profesional (bar, restaurantes, hoteles y espacios exteriores). Estructura de aluminio con efecto antracita metalizado. Estructura robusta compuesta por 2 parasoles juntos y soportados por un único palo.

NL  
Evolutie van de enkele parasol astro met innovatief openings- en sluitsysteem ondersteund door een gasveer. Intrekbaar naar de mast met systeem dat openen en sluiten boven tafels en stoelen mogelijk maakt zonder het meubilair te verplaatsen. Geschikt voor alle locaties en aanbevolen voor een commerciële toepassing (bars, restaurants, hotels). Aluminium frame met antraciet metallic effect. Sterke constructie bestaande uit 2 parasols naast elkaar en verankerd aan een enkele mast.

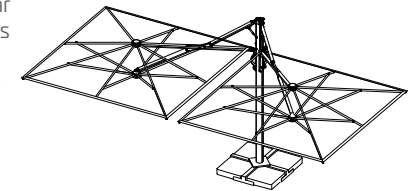

300x600





# Dual "V" StarWhite



I  
Evoluzione dell'ombrellone singolo astro con innovativo sistema di apertura e chiusura assistito tramite molla a gas. Struttura retrattile che permette apertura e chiusura al di sopra di tavoli e sedie senza dover spostare gli arredi. Adatto per tutti gli ambienti e consigliato per uso professionale (bar, ristoranti, hotel e dehor). Telaio in alluminio con verniciatura bianco starwhite opaco. Struttura robusta composta da 2 ombrelloni affiancati ed ancorati ad un unico sostegno.

EN  
Evolution of the single parasol astro with innovative opening and closing system assisted by a gas spring. Retractable structure that allows opening and closing above tables and chairs without moving the furniture. Suitable for all environments and recommended for a commercial employ (bars, restaurants, hotels and terrace dehors). Aluminium frame with opac starwhite finish. Strong structure composed of 2 parasols side by side and anchored to a single support.

D  
Entwicklung des Einzelschirmes Astro mit innovativem Oeffnungs- und Schliess-System. Mit Unterstuetzung durch eine Gasfeder Einziehbares Gestell, das das Oeffnen und Schliessen ueber Tische und Stuehle ermöglicht, ohne die Moebel umzuräumen Geeignet fuer alle Umgebungen und empfohlen fuer einen gewerblichen Einsatz (Bars, Restaurants, Hotels Und Terrassen) Aluminiumgestell mit matt weiss Effekt Starkes Gestell, bestehend aus 2 Sonnenschirmen, die nebeneinander stehen und an einem Mast verankert sind.

F  
Parasols double avec système innovant d'ouverture et de fermeture assisté par ressort à gaz. Structure rétractable qui permet d'ouvrir et de fermer les parasols au-dessus des tables et des chaises sans avoir à déplacer le mobilier. Convient à tous les environnements et recommandé pour un usage professionnel (bars, restaurants, hôtels, collectivité . Chr....). Cadre en aluminium coloris blanc mate. Structure robuste composée de 2 parasols accroche a un seul support.

E  
Evolución del parasol individual astro con el nuevo sistema de apertura y cierre mediante pistón de gas. Estructura retráctil que permite abrir y cerrar el parasol por encima de las sillas y las mesas sin necesidad de apartar el mobiliario. Adecuado para todos los ambientes y recomendado para uso profesional (bar, restaurantes, hoteles y espacios exteriores). Estructura de aluminio con pintura blanca starwhite mate. Estructura robusta compuesta por 2 parasoles juntos y soportados por un único palo.

NL  
Evolutie van de enkele parasol astro met innovatief openings- en sluitsysteem ondersteund door een gasveer. Intrekbaar naar de mast met systeem dat openen en sluiten boven tafels en stoelen mogelijk maakt zonder het meubilair te verplaatsen. Geschikt voor alle locaties en aanbevolen voor een commerciële toepassing (bars, restaurants, hotels). Aluminium frame in mat wit. Sterke constructie bestaande uit 2 parasols naast elkaar en verankerd aan een enkele mast.

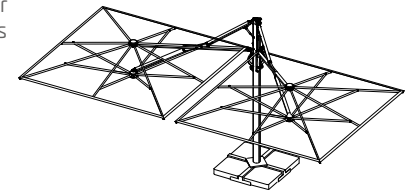

300x600







# Dual "V" Timber

**I**  
Evoluzione dell'ombrellone singolo astro con innovativo sistema di apertura e chiusura assistito tramite molla a gas. Struttura retrattile che permette apertura e chiusura al di sopra di tavoli e sedie senza dover spostare gli arredi. Adatto per tutti gli ambienti e consigliato per uso professionale (bar, ristoranti, hotel e dehor). Telaio in alluminio e finitura effetto legno, trattamento resistente all'acqua salata e alla degradazione uv. Effetto innovativo e molto apprezzato nel settore outdoor. Struttura robusta composta da 2 ombrelloni affiancati ed ancorati ad un unico sostegno.

**EN**  
Evolution of the single parasol astro with innovative opening and closing system assisted by a gas spring. Retractable structure that allows opening and closing above tables and chairs without moving the furniture. Suitable for all environments and recommended for a commercial employ (bars, restaurants, hotels and terrace dehors). With highly durable wood finish aluminum frame. Impervious to saltwater and uv degradation. An innovative and highly appreciated effect in the outdoor branch. Strong structure composed of 2 parasols side by side and anchored to a single support.

**D**  
Entwicklung des Einzelschirmes Astro mit innovativem Oeffnungs- und Schliesssystem. Mit Unterstuetzung durch eine Gasfeder Einziehbares Gestell, das das Oeffnen und Schliessen ueber Tische Und Stuehle ermoeglicht, ohne die Moebel umzuraeumen Geeignet fuer alle Umgebungen und empfohlen fuer einen gewerblichen Einsatz (Bars, Restaurants, Hotels Und Terrassen) Aluminium Gestell mit Holzeffekt. Undurchlaessig gegen Salzwasser und Uv-Degradation Innovativ und hochgeschaeztzt in der Outdoor-Branche. Starkes Gestell, bestehend aus 2 Sonnenschirmen, die nebeneinander stehen und an einem Mast verankert sind.

**F**  
Parasols double avec système innovant d'ouverture et de fermeture assisté par ressort à gaz. Structure rétractable qui permet d'ouvrir et de fermer les parasols au-dessus des tables et des chaises sans avoir à déplacer le mobilier. Convient à tous les environnements et recommandé pour un usage professionnel (bars, restaurants, collectivites, chr...). Cadre en aluminium effet bois. Traitement résistant à l'eau salée et à la dégradation par les uv. Effet innovant et très apprécié dans le secteur outdoor. Structure robuste composée de 2 parasols accroché à un seul mat.

**E**  
Evolución del parasol individual astro con el nuevo sistema de apertura y cierre mediante pistón de gas. Estructura retráctil que permite abrir y cerrar el parasol por encima de las sillas y las mesas sin necesidad de apartar el mobiliario. Adecuado pata todos los ambientes y recomendado para uso profesional (bar, restaurantes, hoteles y espacios exteriores). Estructura de aluminio y acabado efecto madera con tratamiento resistente al agua salina y a la degradación por los rayos uv. Acabado novedoso y muy apreciado en el sector outdoor. Estructura robusta compuesta por 2 parasoles juntos y soportados por un único palo.

**NL**  
Evolutie van de enkele parasol astro met innovatief openings- en sluitsysteem ondersteund door een gasveer. Intrekbaar naar de mast met systeem dat openen en sluiten boven tafels en stoelen mogelijk maakt zonder het meubilair te verplaatsen. Geschikt voor alle locaties en aanbevolen voor een commerciële toepassing (bars, restaurants, hotels). Met fraai in houtdecor afgewerkt aluminium frame. Ongevoelig voor zout water en uv-degradatie. Sterke constructie bestaande uit 2 parasols naast elkaar en verankerd aan een enkele mast.

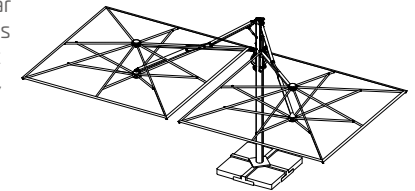

300x600



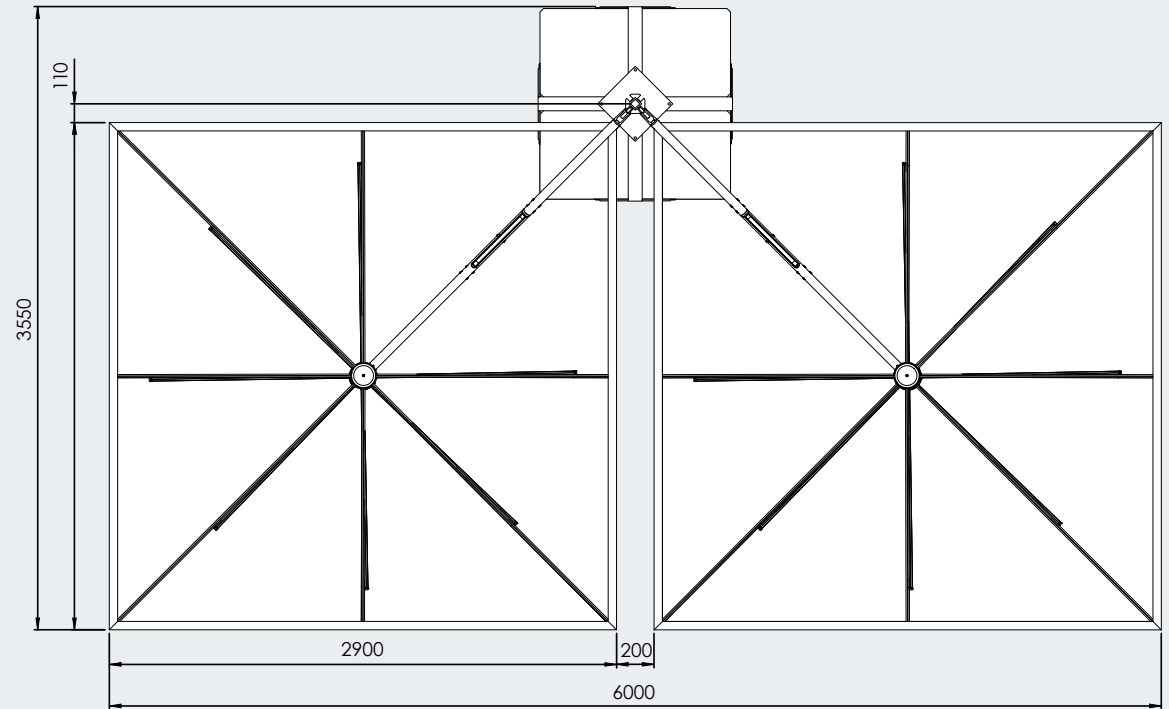

# Dual-V

Carbon  
StarWhite  
Timber

3,0x6,0



CHARACTERISTICS							FINISHING					
COD												
CARBON C3060 DVC				CARBON		CARBON						
STARWHITE C3060 DVW	120	0,60	110x110	STAR WHITE	8	STAR WHITE	18x30	•	•	•	•	•
TIMBER C3060 DVL				TIMBER		TIMBER						

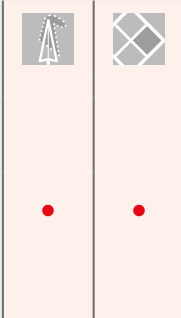
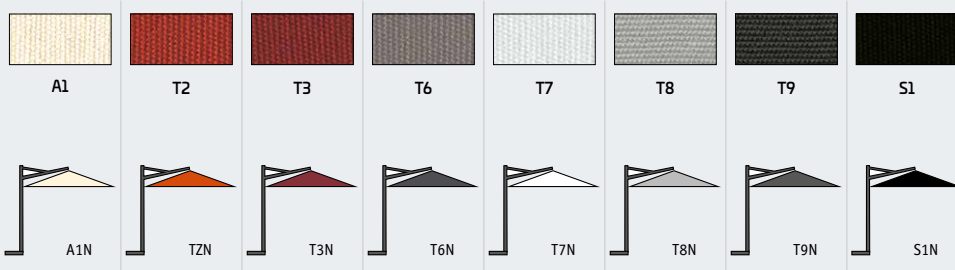
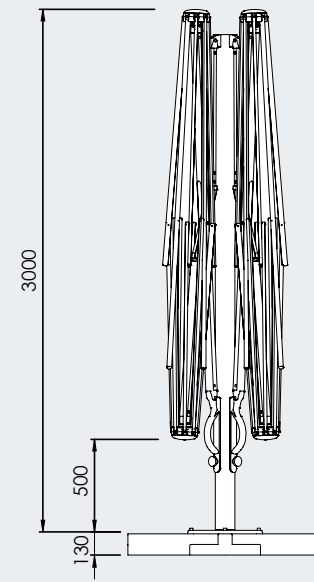
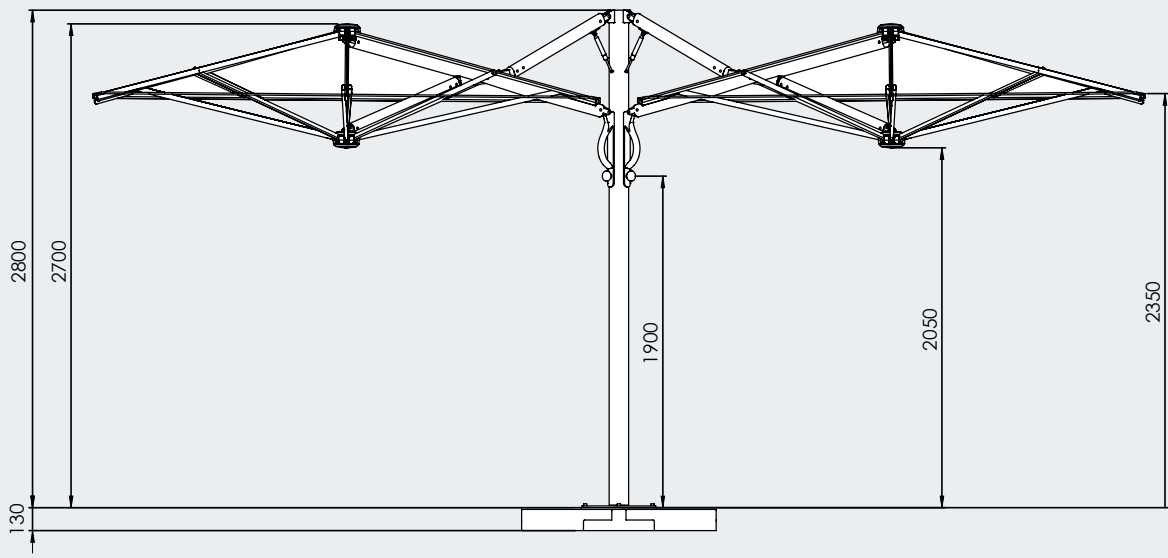

**OPTIONAL**

		SEE PAGE 48
N°4 BC5151 N°12 BC5050	N°4 BV5050	
		<b>FISSAGGIO TERRA GROUND FIXING</b>





# Dual "T" Carbon



I  
Evoluzione dell'ombrellone singolo astro con innovativo sistema di apertura e chiusura assistito tramite molla a gas. Struttura retrattile che permette apertura e chiusura al di sopra di tavoli e sedie senza dover spostare gli arredi. Adatto per tutti gli ambienti e consigliato per uso professionale (bar, ristoranti, hotel e dehor). Telaio in alluminio con effetto antracite metallizzato. Struttura robusta composta da 2 ombrelloni opposti ancorati ad un unico sostegno e posizionati in modo simmetrico.

EN  
Evolution of the single parasol astro with innovative opening and closing system assisted by a gas spring. Retractable structure that allows opening and closing above tables and chairs without moving the furniture. Suitable for all environments and recommended for a commercial employ (bars, restaurants, hotels and terrace dehors). Aluminum frame with metallic anthracite effect. Strong structure composed of 2 parasols anchored to a single support and positioned in a symmetrical way.

D  
Entwicklung des Einzelschirmes Astro mit innovativem Oeffnungs- und Schliesssystem. Mit Unterstuetzung durch eine Gasfeder Einziehbares Gestell, das das Oeffnen und Schliessen ueber Tische und Stuehle ermoeglicht, ohne die Moebel umzuraeumen Geeignet fuer alle Umgebungen und empfohlen fuer einen gewerblichen Einsatz (Bars, Restaurants, Hotels Und Terrassen) Aluminiumgestell mit anthrazitgrau Metallic-Effekt Starkes Gestell, bestehend aus 2 Sonnenschirmen, sie symmetrisch an einem Mast verankert sind.

F  
Parasols double avec système innovant d'ouverture et de fermeture assisté par ressort à gaz. Structure rétractable qui permet d'ouvrir et de fermer les parasols au-dessus des tables et des chaises sans avoir à déplacer le mobilier. Convient à tous les environnements et recommandé pour un usage professionnel (bars, restaurants, collectivites, chr....). Cadre en aluminium effet anthracite métalise. Structure robuste composée de 2 parasols accroche à un seul mat et positionnes symetriquement.

E  
Evolución del parasol individual astro con el nuevo sistema de apertura y cierre mediante pistón de gas. Estructura retráctil que permite abrir y cerrar el parasol por encima de las sillas y las mesas sin necesidad de apartar el mobiliario. Adecuado pata todos los ambientes y recomendado para uso profesional (bar, restaurantes, hoteles y espacios exteriores). Estructura de aluminio con efecto antracita metalizado. Estructura robusta compuesta por 2 parasoles opuestos y soportados por un único palo, posicionados en modo simétrico.

NL  
Evolutie van de enkele parasol astro met innovatief openings- en sluitsysteem ondersteund door een gasveer. Intrekbaar naar de mast met systeem dat openen en sluiten boven tafels en stoelen mogelijk maakt zonder het meubilair te verplaatsen. Geschikt voor alle locaties en aanbevolen voor een commerciële toepassing (bars, restaurants, hotels). Aluminium frame met antraciet metallic effect. Sterke constructie bestaande uit 2 parasols symetrisch naast elkaar en verankerd aan een enkele mast.

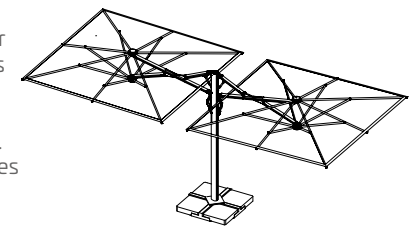

300x600  
350x700





# Dual "T" StarWhite



I  
Evoluzione dell'ombrellone singolo astro con innovativo sistema di apertura e chiusura assistito tramite molla a gas. Struttura retrattile che permette apertura e chiusura al di sopra di tavoli e sedie senza dover spostare gli arredi. Adatto per tutti gli ambienti e consigliato per uso professionale (bar, ristoranti, hotel e dehor). Telaio in alluminio con verniciatura bianco starwhite opaco. Struttura robusta composta da 2 ombrelloni opposti ancorati ad un unico sostegno e posizionati in modo simmetrico.

EN  
Evolution of the single parasol astro with innovative opening and closing system assisted by a gas spring. Retractable structure that allows opening and closing above tables and chairs without moving the furniture. Suitable for all environments and recommended for a commercial employ (bars, restaurants, hotels and terrace dehors). Aluminium frame with opac starwhite finish. Strong structure composed of 2 parasols anchored to a single support and positioned in a symmetrical way.

D  
Entwicklung des Einzelschirmes Astro mit innovativem Oeffnungs- und Schliesssystem. Mit Unterstuetzung durch eine Gasfeder Einziehbares Gestell, das das Oeffnen und Schliessen ueber Tische und Stuehle ermöglicht, ohne die Moebel umzuraeumen Geeignet fuer alle Umgebungen und empfohlen fuer einen gewerblichen Einsatz (Bars, Restaurants, Hotels Und Terrassen)  
Aluminiumgestell mit matt weiss Effekt Starkes Gestell, bestehend aus 2 Sonnenschirmen, die symmetrisch an einem Mast verankert Sind.

F  
Parasols double avec système innovant d'ouverture et de fermeture assisté par ressort à gaz. Structure rétractable qui permet d'ouvrir et de fermer les parasols au-dessus des tables et des chaises sans avoir à déplacer le mobilier. Convient à tous les environnements et recommandé pour un usage professionnel (bars, restaurants, collectivite , ch....). Cadre en aluminium coloris blanc mate. Structure robuste composée de 2 parasols accroche a un seul support mat et positionnes symetriquement.

E  
Evolución del parasol individual astro con el nuevo sistema de apertura y cierre mediante pistón de gas. Estructura retráctil que permite abrir y cerrar el parasol por encima de las sillas y las mesas sin necesidad de apartar el mobiliario. Adecuado pata todos los ambientes y recomendado para uso profesional (bar, restaurantes,hoteles y espacios exteriores). Estructura de aluminio con pintura blanca starwhite mate. Estructura robusta compuesta por 2 parasoles opuestos, soportados por un único palo y posicionados en modo simétrico.

NL  
Evolutie van de enkele parasol astro met innovatief openings- en sluitsysteem ondersteund door een gasveer. Intrekbaar naar de mast met systeem dat openen en sluiten boven tafels en stoelen mogelijk maakt zonder het meubilair te verplaatsen. Geschikt voor alle locaties en aanbevolen voor een commerciële toepassing (bars, restaurants, hotels). Aluminium frame in mat wit. Sterke constructie bestaande uit 2 parasols symmetrisch naast elkaar en verankerd aan een enkele mast.

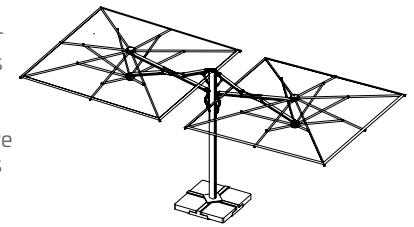

■ ■  
300x600  
350x700







# Dual "T" Timber

I  
Evoluzione dell'ombrellone singolo astro con innovativo sistema di apertura e chiusura assistito tramite molla a gas. Struttura retrattile che permette apertura e chiusura al di sopra di tavoli e sedie senza dover spostare gli arredi. Adatto per tutti gli ambienti e consigliato per uso professionale (bar, ristoranti, hotel e dehor). Telaio in alluminio e finitura effetto legno, trattamento resistente all'acqua salata e alla degradazione uv. Effetto innovativo e molto apprezzato nel settore outdoor. Struttura robusta composta da 2 ombrelloni opposti ancorati ad un unico sostegno e posizionati in modo simmetrico.

EN  
Evolution of the single parasol astro with innovative opening and closing system assisted by a gas spring. Retractable structure that allows opening and closing above tables and chairs without moving the furniture. Suitable for all environments and recommended for a commercial employ (bars, restaurants, hotels and terrace dehors). With highly durable wood finish aluminum frame. Impervious to saltwater and uv degradation. An innovative and highly appreciated effect in the outdoor branch. Strong structure composed of 2 parasols anchored to a single support and positioned in a symmetrical way.

D  
Entwicklung des Einzelschirmes Astro mit innovativem Oeffnungs- und Schliesssystem. Mit Unterstuetzung durch eine Gasfeder Einziehbares Gestell, das das Oeffnen und Schliessen ueber Tische und Stuehle ermoeglicht, ohne die Moebel umzuräumen Geeignet fuer alle Umgebungen und empfohlen fuer einen gewerblichen Einsatz (Bars, Restaurants, Hotels Und Terrassen) Aluminium Gestell mit Holzeffekt. Undurchlaessig gegen Salzwasser und Uv-Degradation Innovativ und hochgeschätzt in der Outdoor-Branche. Starkes Gestell, bestehend aus 2 Sonnenschirmen, die symmetrisch an einem Mast verankert sind.

F  
Parasols double avec système innovant d'ouverture et de fermeture assisté par ressort à gaz. Structure rétractable qui permet d'ouvrir et de fermer les parasols au-dessus des tables et des chaises sans avoir à déplacer le mobilier. Convient à tous les environnements et recommandé pour un usage professionnel (bars, restaurants, collectivités, chr...). Cadre en aluminium effet bois. Traitement résistant à l'eau salée et à la dégradation par les uv. Effet innovant et très apprécié dans le secteur outdoor. Structure robuste composée de 2 parasols accroché à un seul support mat et positionnés symétriquement.

E  
Evolución del parasol individual astro con el nuevo sistema de apertura y cierre mediante pistón de gas. Estructura retráctil que permite abrir y cerrar el parasol por encima de las sillas y las mesas sin necesidad de apartar el mobiliario. Adecuado para todos los ambientes y recomendado para uso profesional (bar, restaurantes, hoteles y espacios exteriores). Estructura de aluminio y acabado efecto madera con tratamiento resistente al agua salina y a la degradación por los rayos uv. Acabado novedoso y muy apreciado en el sector outdoor. Estructura robusta compuesta por 2 parasoles opuestos, soportados por un único palo y posicionados en modo simétrico.

NL  
Evolutie van de enkele parasol astro met innovatief openings- en sluitsysteem ondersteund door een gasveer. Intrekbaar naar de mast met systeem dat openen en sluiten boven tafels en stoelen mogelijk maakt zonder het meubilair te verplaatsen. Geschikt voor alle locaties en aanbevolen voor een commerciële toepassing (bars, restaurants, hotels). Met fraai in houtdecor afgewerkt aluminium frame. Ongevoelig voor zout water en uv-degradatie. Sterke constructie bestaande uit 2 parasols symmetrisch naast elkaar en verankerd aan een enkele mast.

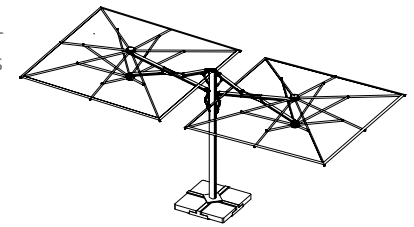





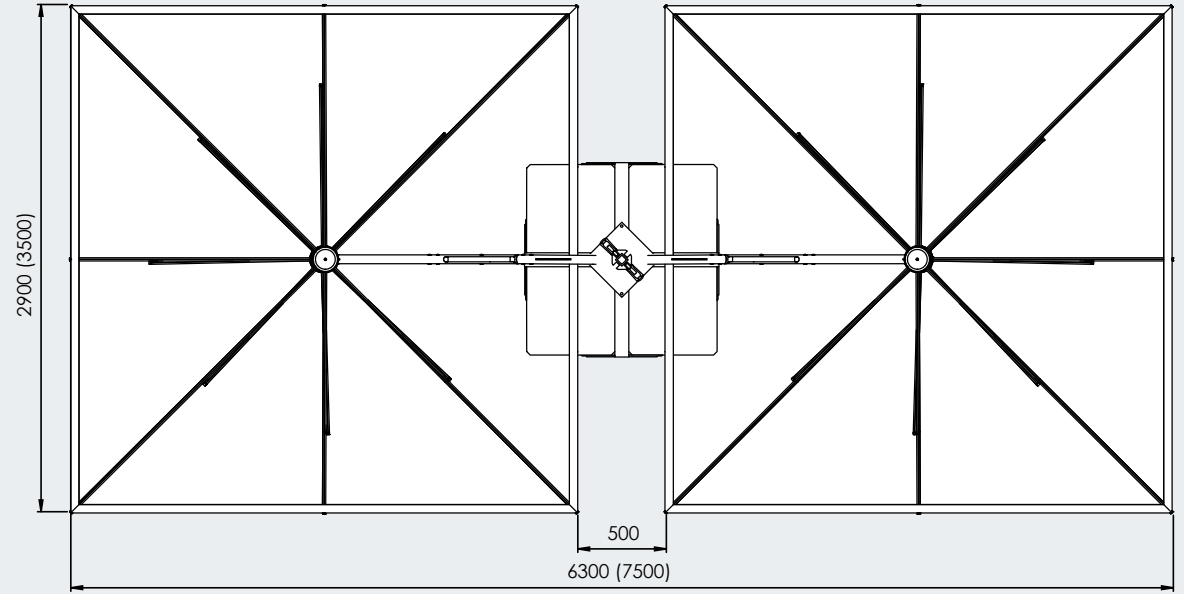





300x600  
350x700





# Dual-T

Carbon  
StarWhite  
Timber

		COD	KG			CHARACTERISTICS			FINISHING						
														INOX	
3,0x6,0		CARBON C3060 DTC	120	0,45	110x110	CARBON	8	CARBON	18x30	●	●	●	●	●	●
		STARWHITE C3060 DTW				STARWHITE		STARWHITE							
		TIMBER C3060 DTL				TIMBER		TIMBER							
3,5x7,0		CARBON C3570 DTC	125	0,45	110x110	CARBON	8	CARBON	18x30	●	●	●	●	●	●
		STARWHITE C3570 DTW				STARWHITE		STARWHITE							
		TIMBER C3570 DTL				TIMBER		TIMBER							

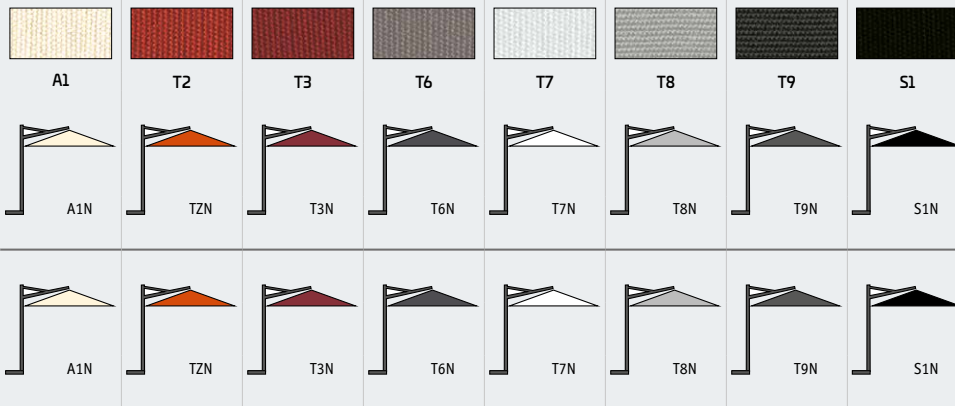
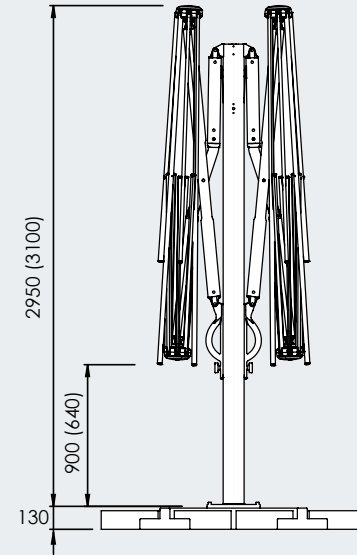
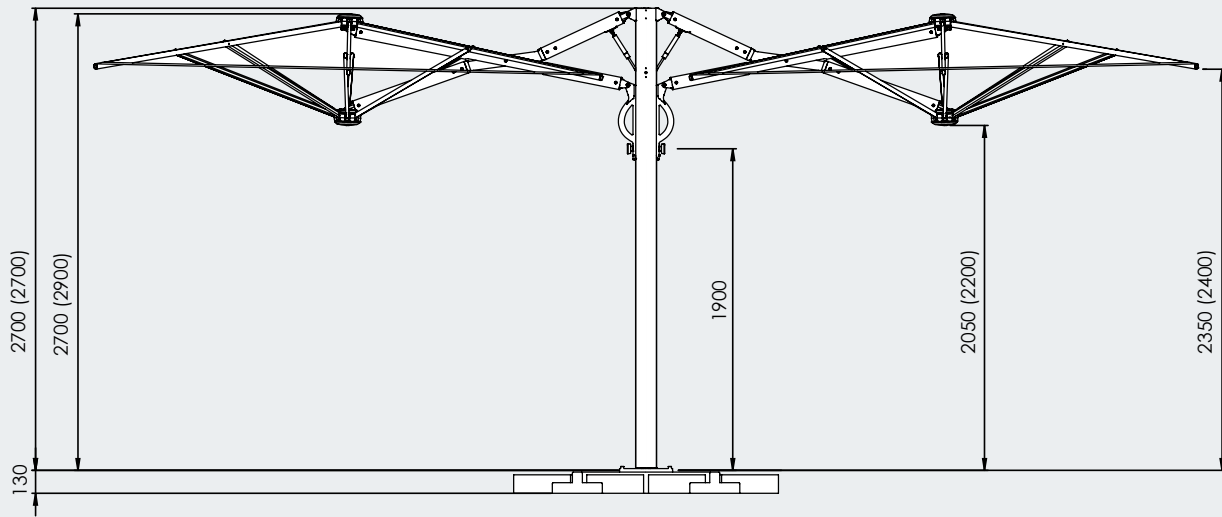

**OPTIONAL**

N°4 BC5151  
N°12 BC5050

N°4 BV5050

SEE PAGE 48

FISSAGGIO TERRA  
GROUND FIXING





# Quattro Carbon



I  
Evoluzione dell'ombrellone singolo astro con innovativo sistema di apertura e chiusura assistito tramite molla a gas. Struttura retrattile che permette apertura e chiusura al di sopra di tavoli e sedie senza dover spostare gli arredi. Adatto per tutti gli ambienti e consigliato per uso professionale (bar, ristoranti, hotel e dehor). Telaio in alluminio con effetto antracite metallizzato. Struttura robusta composta da 4 ombrelloni ancorati ad un unico sostegno.

EN  
Evolution of the single parasol astro with innovative opening and closing system assisted by a gas spring. Retractable structure that allows opening and closing above tables and chairs without moving the furniture. Suitable for all environments and recommended for a commercial employ (bars, restaurants, hotels and terrace dehors). Aluminum frame with metallic anthracite effect. Strong structure composed of 4 parasols anchored to a single support.

D  
Entwicklung des Einzelschirmes Astro mit innovativem Oeffnungs- und Schliesssystem. Mit Unterstuetzung durch eine Gasfeder Einziehbares Gestell, das das Oeffnen dnd Schliessen ueber Tische und Stuehle ermoeoglicht, ohne die Moebel umzuräumen Geeignet fuer alle Umgebungen und empfohlen fuer einen gewerblichen Einsatz (Bars, Restaurants, Hotels Und Terrassen)  
Aluminiumgestell mit anthrazitgrau Metallic-Effekt Starkes Gestell, bestehend aus 4 Sonnenschirmen, die an einem Mast verankert sind.

F  
Parasol quadruple avec système innovant d'ouverture et de fermeture assisté par ressort à gaz. Structure rétractable qui permet d'ouvrir et de fermer le parasol au-dessus des tables et des chaises sans avoir à déplacer le mobilier. Convient à tous les environnements et recommandé pour un usage professionnel (bars, restaurants, collectivités, chr....). Cadre en aluminium à effet anthracite métalisée. Structure robuste composée de 4 parasols accroches à un seul mat.

E  
Evolución del parasol individual astro con el nuevo sistema de apertura y cierre mediante pistón de gas. Estructura retráctil que permite abrir y cerrar el parasol por encima de las sillas y las mesas sin necesidad de apartar el mobiliario. Adecuado pata todos los ambientes y recomendado para uso profesional (bar, restaurantes, hoteles y espacios exteriores). Estructura de aluminio con efecto antracita metalizado. Estructura robusta compuesta por 4 parasols soportados por un único palo.

NL  
Evolutie van de enkele parasol astro met innovatief openings- en sluitsysteem ondersteund door een gasveer. Intrekbaar naar de mast met systeem dat openen en sluiten boven tafels en stoelen mogelijk maakt zonder het meubilair te verplaatsen. Geschikt voor alle locaties en aanbevolen voor een commerciële toepassing (bars, restaurants, hotels). Aluminium frame met antraciet metallic effect. Sterke constructie bestaande uit 4 parasols verankerd aan een enkele mast.

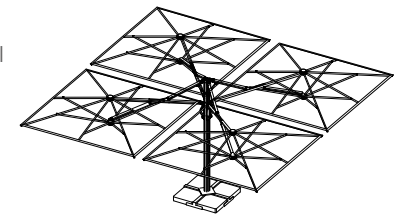

600x600





# Quattro StarWhite



I  
Evoluzione dell'ombrellone singolo astro con innovativo sistema di apertura e chiusura assistito tramite molla a gas. Struttura retrattile che permette apertura e chiusura al di sopra di tavoli e sedie senza dover spostare gli arredi. Adatto per tutti gli ambienti e consigliato per uso professionale (bar, ristoranti, hotel e dehor). Telaio in alluminio con verniciatura bianco starwhite opaco. Struttura robusta composta da 4 ombrelloni ancorati ad un unico sostegno.

EN  
Evolution of the single parasol astro with innovative opening and closing system assisted by a gas spring. Retractable structure that allows opening and closing above tables and chairs without moving the furniture. Suitable for all environments and recommended for a commercial employ (bars, restaurants, hotels and terrace dehors). Aluminium frame with opac starwhite finish. Strong structure composed of 4 parasols anchored to a single support.

D  
Entwicklung des Einzelschirmes Astro mit innovativem Oeffnungs- und Schliesssystem. Mit Unterstuetzung durch eine Gasfeder Einziehbares Gestell, das das Oeffnen und Schliessen ueber Tische und Stuehle ermoeoglicht, ohne die Moebel umzuräumen Geeignet fuer alle Umgebungen und empfohlen fuer einen gewerblichen Einsatz (Bars, Restaurants, Hotels Und Terrassen)  
Aluminiumgestell mit matt weiss Effekt Starkes Gestell, bestehend aus 4 Sonnenschirmen, die an einem Mast verankert sind.

F  
Parasol quadruple avec système innovant d'ouverture et de fermeture assisté par ressort à gaz. Structure rétractable qui permet d'ouvrir et de fermer le parasol au-dessus des tables et des chaises sans avoir à déplacer le mobilier. Convient à tous les environnements et recommandé pour un usage professionnel (bars, restaurants, collectivites, chr....). Cadre en aluminium coloris blanc mat. Structure robuste composée de 4 parasols accroches à un seul mat.

E  
Evolución del parasol individual astro con el nuevo sistema de apertura y cierre mediante pistón de gas. Estructura retráctil que permite abrir y cerrar el parasol por encima de las sillas y las mesas sin necesidad de apartar el mobiliario. Adecuado pata todos los ambientes y recomendado para uso profesional (bar, restaurantes, hoteles y espacios exteriores). Estructura de aluminio con pintura blanca starwhite mate. Estructura robusta compuesta por 4 parasoles soportados por un único palo.

NL  
Evolutie van de enkele parasol astro met innovatief openings- en sluitsysteem ondersteund door een gasveer. Intrekbaar naar de mast met systeem dat openen en sluiten boven tafels en stoelen mogelijk maakt zonder het meubilair te verplaatsen. Geschikt voor alle locaties en aanbevolen voor een commerciële toepassing (bars, restaurants, hotels). Aluminium frame in mat wit. Sterke constructie bestaande uit 4 parasols verankerd aan een enkele mast.

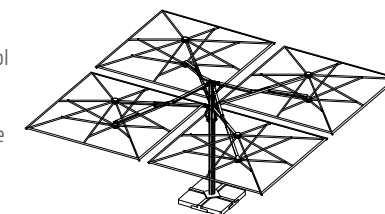



# Quattro Timber



I  
Evoluzione dell'ombrellone singolo astro con innovativo sistema di apertura e chiusura assistito tramite molla a gas. Struttura retrattile che permette apertura e chiusura al di sopra di tavoli e sedie senza dover spostare gli arredi. Adatto per tutti gli ambienti e consigliato per uso professionale (bar, ristoranti, hotel e dehor). Telaio in alluminio e finitura effetto legno, trattamento resistente all'acqua salata e alla degradazione uv. Effetto innovativo e molto apprezzato nel settore outdoor. Struttura robusta composta da 4 ombrelloni ancorati ad un unico sostegno.

EN  
Evolution of the single parasol astro with innovative opening and closing system assisted by a gas spring. Retractable structure that allows opening and closing above tables and chairs without moving the furniture. Suitable for all environments and recommended for a commercial employ (bars, restaurants, hotels and terrace dehors). With highly durable wood finish aluminum frame. Impervious to saltwater and uv degradation. An innovative and highly appreciated effect in the outdoor branch. Strong structure composed of 4 parasols anchored to a single support.

D  
Entwicklung des Einzelschirmes Astro mit innovativem Oeffnungs- und Schliesssystem. Mit Unterstuetzung durch eine Gasfeder Einziehbares Gestell, das das Oeffnen und Schliessen ueber Tische und Stuehle ermoeoglicht, ohne die Moebel umzuräumen Geeignet fuer alle Umgebungen und empfohlen fuer einen gewerblichen Einsatz (Bars, Restaurants, Hotels Und Terrassen) Aluminium Gestell mit Holzeffekt. Undurchlaessig gegen Salzwasser und Uv-Degradation Innovativ und hochgeschaezt in der Outdoor-Branche. Starkes Gestell, bestehend aus 4 Sonnenschirmen, die an einem Mast verankert Sind.

F  
Parasol quadruple avec système innovant d'ouverture et de fermeture assisté par ressort à gaz. Structure rétractable qui permet d'ouvrir et de fermer le parasol au-dessus des tables et des chaises sans avoir à déplacer le mobilier. Convient à tous les environnements et recommandé pour un usage professionnel (bars, restaurants, collectivities, chr....). Cadre en aluminium effet bois. Traitement résistant à l'eau salée et à la dégradation par les uv. Structure robuste composée de 4 parasols accroches à un seul mat.

E  
Evolución del parasol individual astro con el nuevo sistema de apertura y cierre mediante pistón de gas. Estructura retráctil que permite abrir y cerrar el parasol por encima de las sillas y las mesas sin necesidad de apartar el mobiliario. Adecuado pata todos los ambientes y recomendado para uso profesional (bar, restaurantes, hoteles y espacios exteriores). Estructura de aluminio y acabado efecto madera con tratamiento resistente al agua salina y a la degradación por los rayos uv. Acabado novedoso y muy apreciado en el sector outdoor. Estructura robusta compuesta por 4 parasoles soportados por un único palo.

NL  
Evolutie van de enkele parasol astro met innovatief openings- en sluitsysteem ondersteund door een gasveer. Intrekbaar naar de mast met systeem dat openen en sluiten boven tafels en stoelen mogelijk maakt zonder het meubilair te verplaatsen. Geschikt voor alle locaties en aanbevolen voor een commerciële toepassing (bars, restaurants, hotels). Met fraai in houtdecor afgewerkt aluminium frame. Ongevoelig voor zout water en uv-degradatie. Sterke constructie bestaande uit 4 parasols verankerd aan een enkele mast.

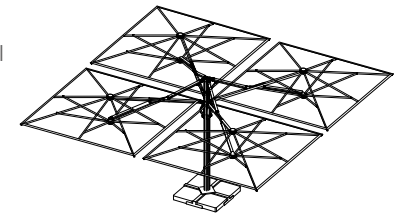

600x600



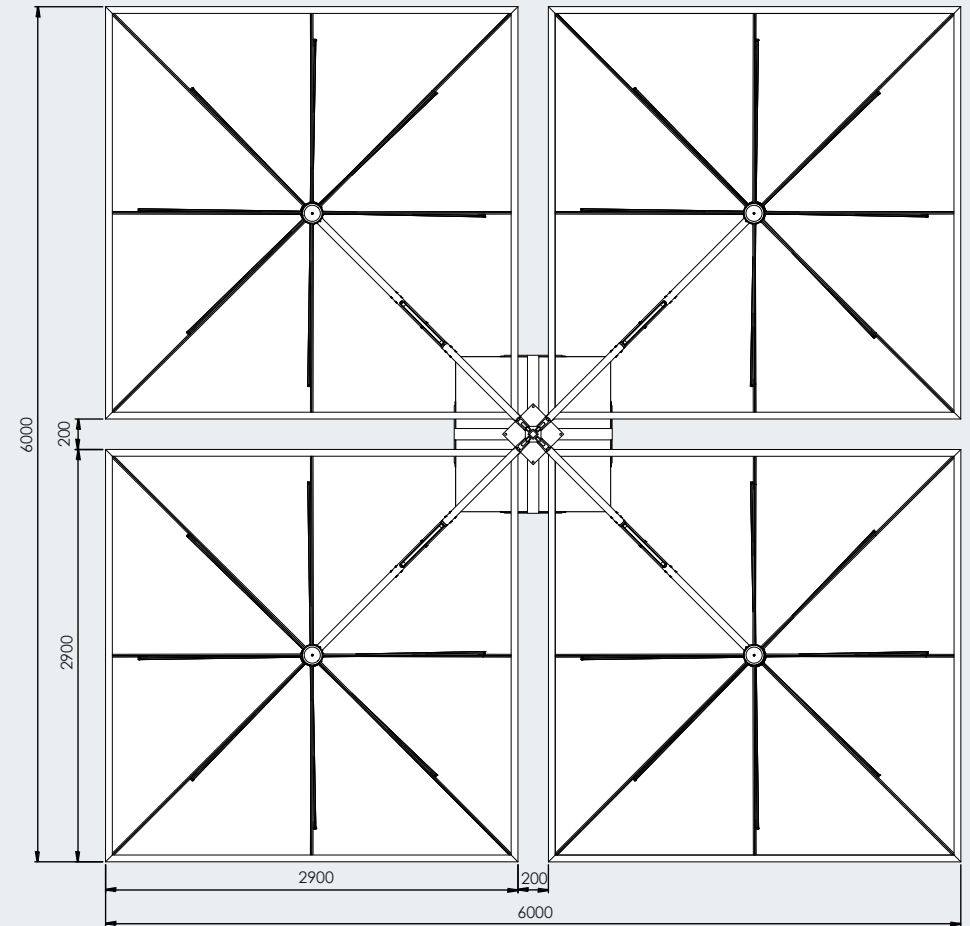

# Quattro

Carbon  
StarWhite  
Timber

6,0x6,0



COD

CARBON  
C6060 QUC

KG

170



0,80



110x110



CARBON

STAR  
WHITE

TIMBER



8



CARBON

STAR  
WHITE

TIMBER



18x30



•



•



•



•



•

INOX

•

## CHARACTERISTICS

## FINISHING

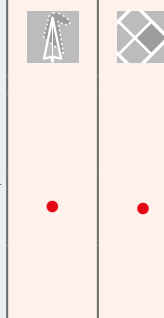
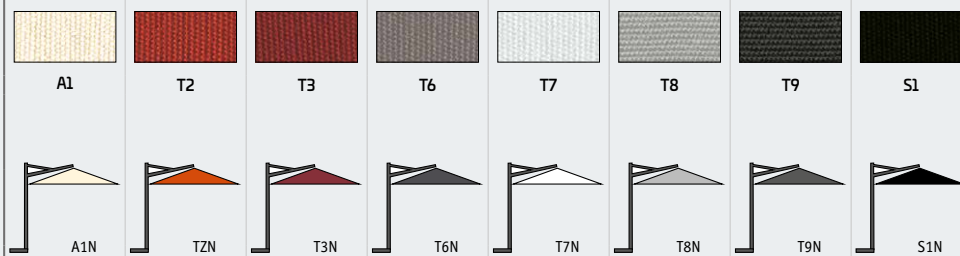
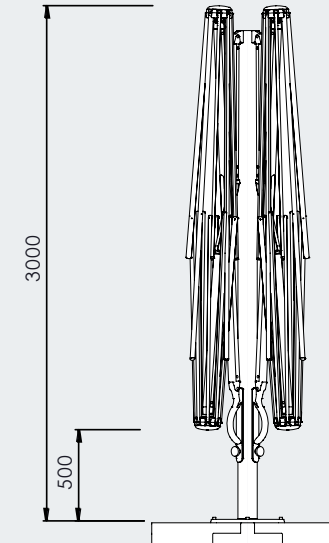
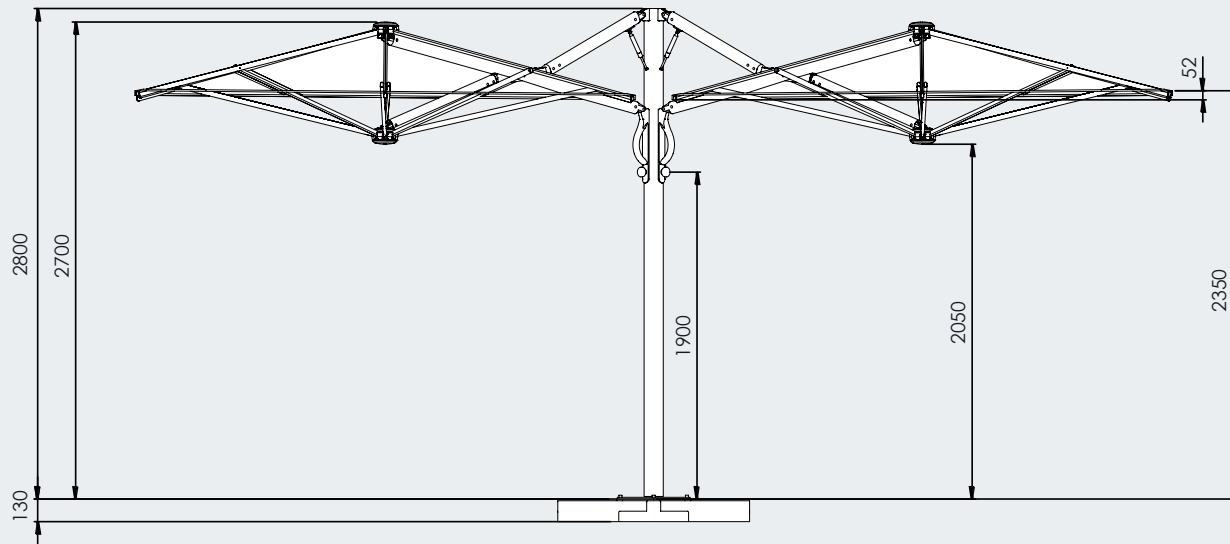

**OPTIONAL**

 N°12 BC5050		SEE PAGE 48 FISSAGGIO TERRA GROUND FIXING

# Ballast



## BC4040 - BC5050

- Piastra in cemento e graniglia. Spessore 4 cm.
- Cement grit slab. Thickness 4 cm.
- Kiesbetonplatte. Dicke 4 cm.
- Dalles ciment et grès. Epaisseur 4 cm.
- Planchas de hormigón y de grava. De espesor 4 cm.
- Gewassen grindtegel. Gewicht 20 kg. Dikte 4 cm.

	COD	KG
400X400	<b>BC4040</b>	14 kg
500X500	<b>BC5050</b>	20 kg



## BC5151 Renewed Design

- Piastra in cemento e graniglia bianca con maniglie. Spessore 11cm. Per ombrelloni a braccio.
- White cement grit slab with handles. Thickness 11cm. For cantilever parasols.
- Weisse Kiesbetonplatte mit Handgriffen. Dicke 11cm. Fuer Pendelschirme.
- Dalles ciment et grès avec poignées blanc. Epaisseur 11cm. Pour parasols avec bras déporté.
- Placas blancas de hormigón y arena con asas. De espesor 11 cm Para parasoles con voladizo.
- Wit gewassen grindtegel met handgrepen. Dikte 11 cm. Geschikt voor vrijhangende parasols.

	COD	KG
500X500	<b>BC5151</b>	60



## BC5151G

- Piastra in cemento grigio con maniglie. Spessore 11cm. Per ombrelloni a braccio.
- Concrete grey cement slab with handles. Thickness 11cm. For cantilever parasols.
- Graue Betonplatte mit Handgriffen. Dicke 11cm. Fuer Pendelschirme.
- Dalles ciment couleur gris avec poignées. Epaisseur 11cm. Pour parasols avec bras déporté.
- Base de cemento gris con asas. De espesor 11 cm. Para parasoles con voladizo.
- Betontegel grijs met handgrepen. Dikte 11 cm. Geschikt voor vrijhangende parasols.

	COD	KG
500X500	<b>BC5151G</b>	60



## BV5050G

- Vaso in cemento grigio con maniglie. Per ombrelloni a braccio.
- Concrete grey cement pot with handles. For cantilever parasols.
- Grauer Betontopf mit Handgriffen. Fuer Pendelschirme.
- Vase ciment couleur gris avec poignées. Pour parasols avec bras déporté.
- Maceta de cemento gris con asas. Para parasoles con voladizo.
- Plantenschaal grijs beton met handgrepen. Geschikt voor vrijhangende parasols.

	COD	H	KG
500x500	<b>BV5050G</b>	270 mm	80



## BV5050B

- Vaso in cemento bianco con maniglie. Per ombrelloni a braccio.
- Concrete white cement pot with handles. For cantilever parasols.
- Weisser Betontopf mit Handgriffen. Fuer Pendelschirme.
- Vase ciment couleur blanc avec poignées. Pour parasols avec bras déporté.
- Maceta de cerámica con asas de hormigón. Para parasoles con voladizo.
- Plantenschaal beton met handgrepen. Geschikt voor vrijhangende parasols.

	COD	H	KG
500x500	<b>BV5050B</b>	270 mm	80



# Carter



BCW

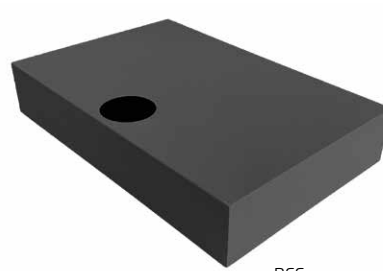

BCC

## BCC/BCW

- Carter acciaio zincato e verniciato a polveri. Colori disponibili carbon-starwhite.
- Zined and epoxy coated steel carter. Available colors carbon-starwhite.
- Verzinkter und pulverbeschichteter Stahlcarter. Erhaeltliche Farben carbon-starwhite.
- Carter acier galvanise' et vernis. Couleurs disponibles carbon-starwhite.
- Carter de acero galvanizado y pintado. Colores disponibles carbon-starwhite.
- Gegalvaniseerd en geepoxeerde metaalcarter. Beschikbare kleuren carbon-starwhite.

	COD	KG
110x72x20	<b>BCC</b>	18
110x72x20	<b>BCW</b>	18

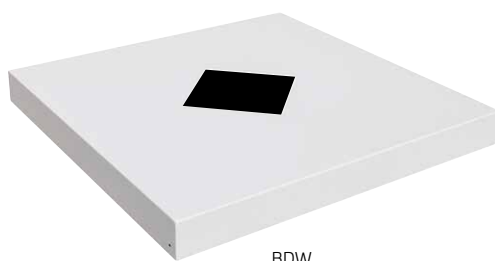

BDW

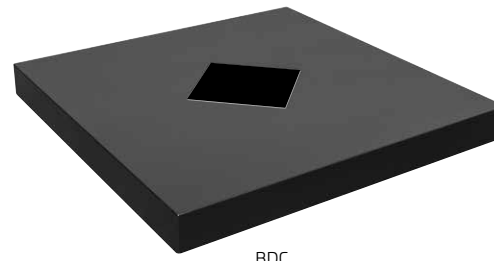

BDC

## BDC/BDW

- Carter acciaio zincato e verniciato a polveri. Colori disponibili carbon-starwhite.
- Zined and epoxy coated steel carter. Available colors carbon-starwhite.
- Verzinkter und pulverbeschichteter Stahlcarter. Erhaeltliche Farben carbon-starwhite.
- Carter acier galvanise' et vernis. Couleurs disponibles carbon-starwhite.
- Carter de acero galvanizado y pintado. Colores disponibles carbon-starwhite.
- Gegalvaniseerd en geepoxeerde metaalcarter. Beschikbare kleuren carbon-starwhite.

	COD	KG
113x113x12	<b>BDC</b>	21
113x113x12	<b>BDW</b>	21

# Ground fixing



## CPBF3030Z

- Contropiastra acciaio zincato per fissaggio a terra. 30x30 cm.
- Small metal plate for concrete ground fixation. 30x30 cm.
- Verzinkte Stahlplatte fuer Bodenbefestigung. 30x30 cm.
- Contreplaque acier galvanise pour ancrage au sol. 30x30 cm.
- Placa acero galvanizado fijación a tierra. 30x30 cm.
- Metaal zinkplaat voor grondbevestiging. 30x30 cm.

	<b>COD</b>	<b>KG</b>
300x300	<b>CPBF3030Z</b>	7



## CPBF6565Z

- Contropiastra acciaio zincato per fissaggio a terra. 65x65 cm.
- Metal plate for concrete ground fixation. 65x65 cm.
- Verzinkte Stahlplatte fuer Bodenbefestigung. 65x65 cm.
- Contreplaque acier galvanise pour ancrage au sol. 65x65 cm.
- Placa acero galvanizado fijación a tierra. 65x65 cm.
- Metaal zinkplaat voor grondbevestiging. 65x65 cm.

	<b>COD</b>	<b>KG</b>
650x650	<b>CPBF6565Z</b>	30



## BTA - INGROUND FIXING ASTRO

- Supporto da interrare. acciaio zincato.
- In ground anchor. zinced steel.
- Bodenanker. Verzinktes stahl.
- Base pour ancrage au sol. acier galvanisé.
- Base para fijación a tierra. acero galvanizado.
- Grondanker. gegalvaniseerd staal.

	<b>COD</b>	<b>H</b>	<b>KG</b>
Ø 160	<b>BTA</b>	350	5



## BTB - INGROUND FIXING DUAL-QUATTRO

- Supporto da interrare. acciaio zincato.
- In ground anchor. zinced steel.
- Bodenanker. verzinktes stahl.
- Base pour ancrage au sol. acier galvanisé.
- Base para fijación a tierra. acero galvanizado.
- Grondanker. gegalvaniseerd staal.

	<b>COD</b>	<b>H</b>	<b>KG</b>
300x300	<b>BTB</b>	330	10

	MOD.	BTB	BTA	BCC	BCW	BDC	BDW	CPBF3030Z	CPBF6565Z
<b>ASTRO</b>	CARBON		•	•				•	•
	STARWHITE		•		•			•	•
	TIMBER		•	•				•	•
	TITANIUM		•	•				•	•
<b>DUAL T</b>	CARBON	•				•			•
	STARWHITE	•					•		•
	TIMBER	•				•			•
<b>DUAL-V</b>	CARBON	•				•			•
	STARWHITE	•					•		•
	TIMBER	•				•			•
<b>QUATTRO</b>	CARBON	•				•			•
	STARWHITE	•					•		•
	TIMBER	•				•			•

## Optional base

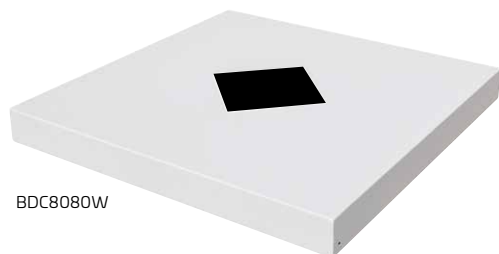

BDC8080W

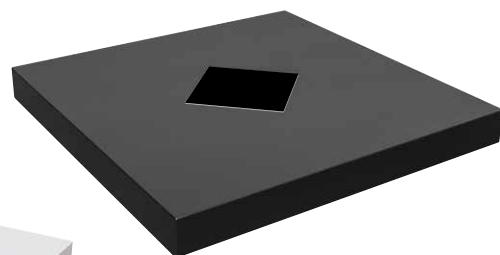

BDC8080C



BUD8080W



BUD8080C



### BDC8080

- Carter acciaio zincato e verniciato a polveri. Colori disponibili carbon-starwhite. Compatibile con base BUD8080.
- Zined and epoxy coated steel carter. Available colors carbon-starwhite. Suitable for base BUD8080.
- Verzinkter und pulverbeschichteter Stahlcarter. Erhaeltliche Farben carbon-starwhite. Kombinierbar mit Staender BUD8080.
- Carter acier galvanisé et vernis. Couleurs disponibles carbon-starwhite. Combinable avec pied BUD8080.
- Carter de acero galvanizado y pintado. Colores disponibles carbon-starwhite. Combinable con base BUD8080.
- Gegalvaniseerd en geepoexeerde metaalcarter. Beschikbare kleuren carbon-starwhite. Combineerbaar met parasolvoet BUD8080.



113x113x12

113x113x12

COD

**BDC8080C**

**BDC8080W**

KG

21

21

### BUD8080

- Base a croce metallica opzionale per ombrellone a braccio da completare con 12 bc4040, non comprese".
- Optional cross metal base for cantilever parasols to be completed with 12 bc4040, not included.
- Alternativer stahlplattenstaender fuer seitenarmschirme zum kombinieren mit 12 bc4040, nicht inbegriffen.
- Pied en acier optionnelle pour parasols bras deporté à combiner avec 12 bc4040, non inclus.
- Base de metal opcional para sombrillas brazo lateral para completar con 12 bc4040, no incluido.
- Optionele metalen basis voor arm parasol uit te voeren met 12 bc4040, niet inbegrepen.



850 x 850

COD

**BUD8080C**

**BUD8080W**





























KG

32

### B8080R

- Kit ruote alta resistenza girevoli e frenanti.
- High resistance rotating and braking wheels kit.
- Hochwiderstands-dreh- und bremsrad set.
- Kit roues rotatives et freinage haute résistance.
- Kit ruedas giratorias y frenos de alta resistenci.
- Kit met hoge weerstand draaiende en remwielen.

# Optional base

MOD.	BUD8080					BDC8080	
	CARBON	STARWHITE				CARBON	STARWHITE
ASTRO	CARBON	•		•		•	
	STARWHITE			•			•
	TIMBER	•		•		•	
	TITANIUM	•		•		•	
DUAL T 3x6	CARBON	•		•		•	
	STARWHITE			•			•
	TIMBER	•		•		•	
DUAL T 3,5x7	CARBON	-		-		-	
	STARWHITE			-			-
	TIMBER	-		-		-	
DUAL-V	CARBON	•		•		•	
	STARWHITE			•			•
	TIMBER	•		•		•	
QUATTRO	CARBON	•		•		•	
	STARWHITE			•			•
	TIMBER	•		•		•	



- In caso di base con ruote, prestare particolare attenzione in caso di vento. Prima di spostare l'ombrellone è necessario chiuderlo.
- In case of base with wheels, be especially careful in windy conditions. Close the parasol before moving it.
- Bei Staender mit Raeder und Wind besonders vorsichtig sein. Der Schirm kann geschlossen bewegt werden.
- Dans le cas d'une base à roues, faites particulièrement attention par temps venteux. Avant de déplacer le parasol, il est nécessaire de le fermer.
- En el caso de una base con ruedas, tenga especial cuidado en condiciones de viento. Antes de mover la sombrilla es necesario cerrarlo.
- Wees vooral voorzichtig met statieven met wielen en wind. De parasol kan in gesloten toestand worden verplaatst.

# Fabric collection



## FATTORE DI PROTEZIONE SOLARE

Limita il passaggio del calore per più del 70%.  
Normativa UNI EN 410:2011

## SOLAR PROTECTION FACTOR

Harmful UV rays and limiting heat circulation  
Norm UNI EN 410:2011



## FATTORE DI PROTEZIONE LUMINOSA

Indica la percentuale di trasmissione della luce  
Normativa UNI EN 410:2011

## FACTOR OF SOLAR LIGHT PROTECTION

% of light transmission  
Norm UNI EN 410:2011



## FATTORE DI PROTEZIONE UPF

Protezione dai raggi U.V. (UPF) dal 85% al 100%  
Normativa UNI EN 13758-1:2007

## UPF PROTECTION FACTOR







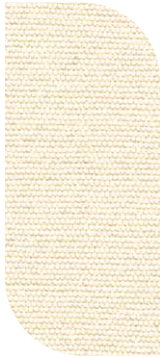
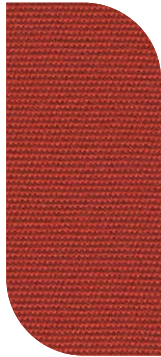
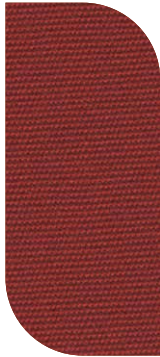

Harmful UV rays. (UPF) from 85% almost 100%  
Norm UNI EN 13758-1:2007

## SCHEDA TECNICA / DATA SHEET

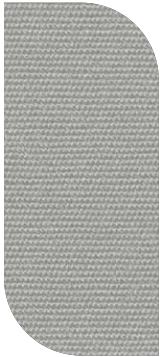
COMPOSIZIONE / COMPOSITION	CARATTERISTICHE / FINISHING	SOLIDITÀ AL COLORE / COLOR FASTNESS	TRATTAMENTO / TREATMENT	IMPERMEABILITÀ / COLONNA D'ACQUA IMPERMEABILITY / WATER COLUMN
350 gr/m2 100% ACRYL	Inattaccabile da muffe e batteri. Solido alla luce Permeabile all'aria Antimacchia	GRADO 7/8 ENSIO 105-B04	RESINE TEFLON IDRO-OLEOREPELLENZA	CIRCA 25 CM
350 gr/m2 100% ACRYL	Resistant to mold and bacteria. Color fast. Breathable. Stain REPELLENT.	GRADE 7/8 ENSIO 105-B04	TEFLON RESIN WATER-OILREPELLENCY	ABOUT 25 CM



# Fabric collection

<b>350</b> <b>GR/M<sup>2</sup></b> <b>ACRYLIC</b>								
	<b>A1</b> ECRU NATURAL COL. NATUR	<b>T2</b> TERRACOTTA ZIEGELROT TERRACOTTA	<b>T3</b> BORDEAUX	<b>T6</b> GRIGIO TAUPE GREY TAUPE GRAU TAUPE GRIS TAUPE GRIJS TAUPE	<b>T7</b> BIANCO WHITE BLANC WEISS	<b>T8</b> GRIGIO PERLA SILVER GREY SILBERGRAU	<b>T9</b> GRIGIO ANTRACITE ANTHRACIT GREY ANTHRACITGRAU	<b>S1</b> NERO / BLACK SCHWARZ NOIRE NEGRO ZWART
	70/80%	> 90%	> 90%	> 90%	70/80%	> 90%	> 90%	> 90%
	20/30%	< 10%	< 10%	< 10%	20/30%	< 10%	< 10%	< 10%
	85/89%	100%	100%	100%	85/89%	100%	100%	100%

I dati forniti, pur essendo frutto di misurazioni scientifiche condotte in laboratori certificati, sono da ritenersi indicativi.  
 The above mentioned data are indicative, although provided by scientific measurements performed in certified laboratories.

# Special Fabric Collection Classe A



G596



G822



R779

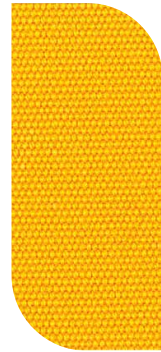

G013



G316



G209



G396



G245



G051

## 350GR/M<sup>2</sup> ACRYLIC

- Gamma tessuti a richiesta. Tessuto mano ombrellone.
- Fabric range on request. Parasol fabric.
- Farbkollektion auf Anfrage. Schirmstoffe.
- Gama de telas bajo pedido. Tejido para sombrillas.
- Kleurencollectie op aanvraag. Paraplu doek.



> 90%



< 10%



100%



# Special Fabric Collection Classe B



G636



G077



G582

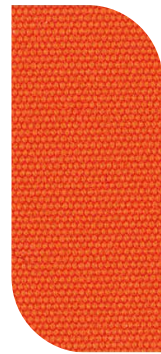

G050



R777



G211

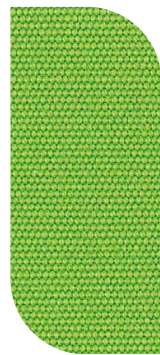

G024



R023



G285



G252

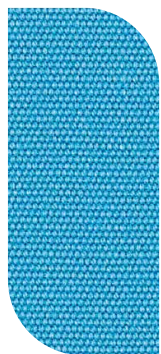

G066



G018

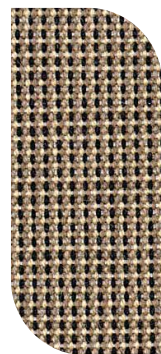

G352



G635

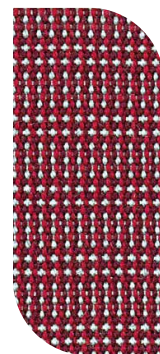

G055

## 350GR/M<sup>2</sup> ACRYLIC

- Gamma tessuti a richiesta. Tessuto mano tende.
- Fabric range on request. Awning fabrics.
- Farbkollektion auf Anfrage. Markisenstoffe.
- Gama de telas bajo pedido. Telas de toldos.
- Kleurencollectie op aanvraag. Zonweringdoek.



> 90%



< 10%



100%



## Kit Led Galaxia

WHITE 3000K

- I Kit led ad alta luminosità sviluppato per le esigenze del settore professionale. Cablatura ed accessori all'interno del prodotto. Si può applicare ai modelli ASTRO, DUAL e QUATTRO. Da predisporre in fase di produzione.

### Il kit è composto da:

- Circuito luminoso a led integrato nella corona centrale inferiore – per utilizzo esterno;
- Luce a led bianca 3000k con telecomando remote control (ON/OFF – dimmer);
- Batteria ricaricabile con autonomia minima di 8 ore, completa di contenitore IP56 e carica batteria;
- In alternativa alimentatore elettronico stabilizzato 220Vac - 12Vdc 60W;
- cablaggio completo per utilizzo in esterno;

- UK Complete high light LED kit developed for a professional and commercial fit. Wiring and accessories inside the product. Suitable for models ASTRO, DUAL and QUATTRO models. To be prepared during production.

### The kit consists of:

- LED light circuit integrated in the lower central crown - for external use;
- 3000k white LED light with remote control remote control (ON / OFF - dimmer);
- Rechargeable battery with a minimum autonomy of 8 hours, with IP56 case and battery charger;
- Alternatively 220Vac stabilized electronic power supply - 12Vdc 60W;
- complete wiring for outdoor use;



**BATTERIA / BATTERY**



CARICA BATTERIA  
BATTERY CHARGER



BATTERIA  
BATTERY

**CORRENTE / POWER**



ALIMENTATORE 220V  
TRANSFORMER 220V



TELECOMANDO IR  
IR REMOTE CONTROL

Descrizione/Description	ASTRO	DUAL	QUATTRO
<p><b>- luce bianca</b> <b>- con collegamento elettrico</b></p> <p>- white light - electrical connection</p>	KIT.LED.GX.W.C	KIT.LED.GXD.W.C.	KIT.LED.GXQ.W.C.
<p><b>- luce bianca</b> <b>- kit batteria</b></p> <p>- white light - battery kit</p>	KIT.LED.GX.W.B	KIT.LED.GXD.W.B	KIT.LED.GXQ.W.B

# Materiali e finiture

## Materials and finishes

### Componenti e profili alluminio

#### Aluminium components and profiles



TIMBER  
- ASTRO  
- DUAL T  
- DUAL V  
- QUATTRO



CARBON  
- ASTRO  
- DUAL T  
- DUAL V  
- QUATTRO



STARWHITE  
- ASTRO  
- DUAL T  
- DUAL V  
- QUATTRO



TITANIUM  
- ASTRO

### Profili stecche

#### Rib profiles



TIMBER  
- ASTRO  
- DUAL T  
- DUAL V  
- QUATTRO



CARBON  
- ASTRO  
- DUAL T  
- DUAL V  
- QUATTRO



STARWHITE  
- ASTRO  
- DUAL T  
- DUAL V  
- QUATTRO



TITANIUM  
- ASTRO

# Accessories



CANALINA-RAINGUTTER



COVER BAG QUATTRO/DUAL



COVER BAG ASTRO

# Uso e Manutenzione

## Acciaio Inox

### Attenzione:

1. NON USARE i seguenti prodotti su parti in acciaio inox:  
Candeggina o detersivi contenenti candeggina (possono corrodere l'acciaio inox).  
Acido cloridrico o prodotti contenenti cloruro (possono corrodere l'acciaio inox).
2. Sale, calcare o acido (bevande o alimenti) possono scolorare le parti in acciaio inox non prontamente pulite.
3. Prodotti o parti in acciaio inox usati in riva al mare o nell'arredo a bordo piscina richiedono più frequenti pulizie per rimuovere i depositi di cloruro e prevenire la corrosione e l'attacco chimico della superficie esterna.
4. Macchie o ruggine che si presentano sulla superficie di acciaio inox devono essere prontamente pulite.
5. Macchie lasciate a lungo possono divenire permanenti.
6. La ruggine può attaccare chimicamente o scavare l'acciaio inox.

### Rimozione di macchie o ruggine:

- Applicare un detersivo non abrasivo specifico per l'acciaio inox.
- Sciacquare abbondantemente con acqua pulita.
- Alla fine asciugare bene per prevenire striature, strofinare nel senso delle fibre.

## Metalli verniciati: Ferro – Alluminio

Per la pulizia delle superfici in metallo verniciato utilizzare acqua fredda e detersivi liquidi non abrasivi e non aggressivi. Applicare con panno morbido. È consigliabile, in caso di superfici molto sporche e/o invecchiate, di trattare, dopo la fase di pulizia, con olio di vaselina. Applicare con panno morbido per rivitalizzare le superfici. Nell'eventualità di macchie dovute a depositi calcarei, passare un panno con soluzione di aceto bianco diluito in acqua fredda.

Prima della stagione invernale eseguire una fase di pulizia e quindi trattare superfici, parti mobili e viti con olio di vaselina, utilizzando un panno morbido.

Piccoli graffi o danneggiamenti delle superfici verniciate, dovuti a trasporto, usi impropri o movimentazione, possono essere ritoccati e protetti dalla corrosione con apposita vernice.

## Legni: Iroko

Tradizionale legno impiegato nell'arredo da esterni e nel settore nautico.

È un legno duro ad alto contenuto di olio adatto all'uso esterno.

Estremamente longevo, è praticamente inalterabile all'esposizione reiterata agli agenti atmosferici. Se non riceve alcun trattamento protettivo, la superficie prenderà una patina grigio argento, naturale protezione della parte interna del legno.

La tendenza naturale del legno di ingrigire o perdere la luminosità della vernice può essere impedita nella fase iniziale di vita del prodotto. È sufficiente trattare nuovamente le parti in legno con impregnante adatto, facile da trovare nei negozi specializzati.

Si applica con un panno, sulle superfici esposte, una soluzione di acqua e olio incolore.

L'olio deve essere molto diluito. Quando la superficie è asciutta, lucidare con panno.

Macchie superficiali possono essere rimosse intervenendo in modo tempestivo, prima che il legno possa assorbirle in profondità.

Carteggiare la superficie interessata e successivamente lucidare con panno.

La corrispondenza ad alti standard qualitativi e funzionali dei materiali impiegati costituisce la garanzia principale della robustezza e resistenza nel tempo dei prodotti Scolaro. Un comportamento rispettoso di norme di manutenzione ed uso, come specificato di seguito, assicura una durata ancora maggiore.

Le informazioni contenute in questo catalogo o in altri stampati pubblicitari della ditta Scolaro, quali caratteristiche tecniche dei prodotti o dei componenti, dimensioni, schemi di montaggio, colori, ecc., hanno valore meramente indicativo, in ragione delle specifiche tecniche e della evoluzione tecnologica dei prodotti aziendali. Al fine di migliorare la qualità del prodotto, la ditta si riserva il diritto di modificare lo stesso senza alcun preavviso e anche dopo l'accettazione dell'ordine. L'azienda si riserva di apportare modifiche parziali o totali ai prodotti senza preavviso declinando ogni responsabilità su eventuali dati inesatti. Eventuali lievi variazioni di tonalità dei colori e delle finiture rientrano nelle normali caratteristiche dei materiali impiegati. Tutte le differenze sopraindicate non sono tali da modificare significativamente i prodotti stessi e non costituiscono motivo di reso o sostituzione della merce o di contestazione.

## Tessuti sintetici: Acrilico – Poliestere

Il tessuto impiegato è trattato antimuffa ed impermeabilizzato per respingere al massimo l'acqua e le macchie mantenendone la traspirabilità. Si raccomanda di seguire le istruzioni seguenti di manutenzione per rendere ottimale la durata del tessuto:

– Togliere periodicamente depositi di polvere, macchie e altro tipo di sporco per evitare che anche dopo la pulizia rimangano tracce visibili.

– È importantissimo assicurarsi che la copertura sia perfettamente asciutta prima di chiudere l'ombrellone.

Durante i mesi di non utilizzo l'ombrellone deve essere riposto in un ambiente asciutto.

Evitare il contatto prolungato con sostanze grasse e/o coloranti che potrebbero venire assorbite dal materiale di rivestimento e dare luogo a macchie permanenti, oltre che deteriorare la struttura del filato. Non usare solventi o detergenti a base di solventi (evitare l'acetone). Utilizzare acqua e detergenti liquidi non abrasivi con PH neutro e incolori. Eventualmente lasciare agire il detergente alcuni minuti. Sciacquare abbondantemente con acqua a temperatura non superiore a 30°C.

## Componenti

Le parti in acciaio, la viteria e gli accessori sono trattati antiruggine. Per garantire e assicurare una maggiore durata del prodotto è consigliabile comunque porre l'ombrellone e la base al riparo durante i mesi invernali o durante i periodi di non utilizzo.

Durante ogni stagione verificare periodicamente lo stato e la funzionalità dei componenti soprattutto dopo un periodo lungo dove l'ombrellone non sia stato utilizzato.

## Avvertenze

Leggere attentamente e conservare le istruzioni di montaggio e il manuale d'uso.

La base va zavorrata con il peso indicato. L'insufficienza di peso sulla base compromette seriamente la stabilità dell'ombrellone.

In caso di vento chiudere sempre l'ombrellone e rimuoverlo dalla struttura. Non lasciare mai l'ombrellone incustodito aperto. Improvvisi colpi di vento possono danneggiare o rovesciare l'ombrellone.

Ricordare sempre che l'ombrellone non è una struttura fissa. La ditta Scolaro non potrà essere ritenuta responsabile per danni ai prodotti forniti, cose o persone derivanti da un utilizzo scorretto e dal mancato rispetto delle istruzioni e direttive su riportate.

## Uso Prodotti

Prima di iniziare la manovra di apertura accertarsi che il telo dell'ombrellone non sia impigliato nelle stecche interne.

Per aprire o chiudere gli ombrelloni girare le manovelle nel senso indicato dalle frecce e dalle diciture "apre" o "chiude": errate manovre possono rompere la corda o il meccanismo.

Non forzare mai le funi o le manovelle: se c'è un impedimento accertarsi della sua origine e rimuovere l'eventuale causa.

Componenti in legno: applicare almeno una volta ogni anno un impregnante.

Corde e parti meccaniche: trattare con olio di vaselina una volta ogni anno prima della stagione invernale. Chiudere gli ombrelloni in presenza di avverse condizioni meteorologiche quali vento e pioggia di forte intensità.

Gli ombrelloni Scolaro sono associabili a specifici basamenti per il fissaggio a terra.

Se si sceglie di posizionarli solo tramite zavorra si certifica la loro idoneità ad un uso normale in condizioni di vento moderato.

Nella tabella dedicata vengono riportate le indicazioni sui pesi minimi delle zavorre.

La fase di installazione dell'ombrellone e la sua gestione è responsabilità esclusiva del Cliente.

## Garanzia

**I prodotti Scolaro sono garantiti per 2 anni da:**

-difetti strutturali non dovuti a impropria o mancata manutenzione

-ruggine invasiva non derivante da graffi o abrasioni da uso e non asportabile con normale pulizia e manutenzione.

La garanzia è limitata ad 1 anno per i meccanismi di apertura a manovella.

Per avvalersi della garanzia, è necessario presentare l'articolo difettoso o foto del prodotto. Sono richiesti anche copia della fattura o scontrino. Scolaro declina ogni responsabilità per danni causati a cose o a persone derivanti da uso non corretto del prodotto.

La garanzia prevede la fornitura di pezzi di ricambio o la sostituzione del prodotto dove necessario.

La garanzia non contempla l'intervento in loco o altri costi sostenuti per il mancato uso del prodotto.

La nuova gamma di tessuti in acrilico assicurano un'ottima resistenza dei colori ai raggi UV e una lunga durata nel tempo. Nuova gamma tessuti acrilico: Sono garantiti da Scolaro per un periodo di 5 anni a seguito di una normale esposizione, all'azione del sole e degli agenti atmosferici in genere.

La garanzia non copre danni derivanti da azioni meccaniche, atti dolosi e cause di forza maggiore. Sono quindi esclusi dalla garanzia danni al tessuto come tagli e abrasioni non rilevati al momento della consegna o derivanti da uso improprio. Per ulteriori informazioni richiedi le condizioni generali di garanzia.

# Use and maintenance

## Stainless steel

### Attention:

1. DO NOT USE THE FOLLOWING PRODUCTS on any parts made of stainless steel:  
Chlorine bleach or detergents containing bleach (they can corrode stainless steel).  
Hydrochloric acid or products containing chlorides (they can corrode stainless steel).
2. Salt, limestone or acids (drinks and food) may discolour parts made of stainless steel if not cleaned promptly.
3. Products or parts made of stainless steel used near the seaside or for the interior decoration of swimming pools require more frequent cleaning in order to remove chlorites deposited on them and to prevent corrosion and chemical deterioration of the external surfaces.
4. Stains or rust noted on stainless steel surfaces must be cleaned promptly.
5. Stains left in place for long periods may become permanent.
6. Rust may cause chemical reactions or corrode stainless steel.

### To remove stains or rust:

- Apply a specific non-abrasive detergent or polish for stainless steel.
- Rinse thoroughly with clean water.
- Lastly, dry thoroughly in order to prevent streaks from occurring, rubbing in the sense of the fibres.

## Varnished metals: Iron and Aluminium

To clean surfaces in varnished metals, use cold water and non-abrasive or aggressive liquid detergents. Apply with a soft cloth. In the case of very dirty and/or aged surfaces, after cleaning, it is advisable to treat them with liquid paraffin. Apply with a soft cloth to revitalize the surfaces. In the event of stains caused by lime deposits on varnishes of coarse structure (eg. antique iron and indian brown) clean them with a cloth and a solution of white wine vinegar diluted in cold water. Before winter, carry out the cleaning phase and then treat the surfaces, moving parts and screws with liquid paraffin, using a soft cloth. Small scratches or damage to the varnished surfaces due to transportation, improper use or handling can be retouched and protected from corrosion with special varnishes.

## Wood: Iroko

Traditional wood employed for outdoor furniture and the marine industry. Iroko is a hardwood with a high oil content, suitable for external use. Extremely long-lasting. It is practically unalterable to repeated exposure to atmospheric factors. If not treated, the surface takes a silver-grey coating which is the natural protection from inside the wood, considered an essential part of Iroko's charm.

The natural tendency of wood to turn gray or lose the brightness of the paint can be prevented in the early stages of the product life. The parasol can be restored by a new treatment with proper products easy to find in specialized shops.

It's necessary to apply a solution of water and colourless oil, to exposed surfaces with a cloth. The oil must be highly diluted. When the surface is dry, polish with a cloth. Superficial stains can be removed by intervening in time, before the wood can fully absorb them. Gently sand the surface in question and then polish with a rough cloth.

The connection between the high qualitative and functional standards of the materials used, constitutes the main guarantee of the sturdiness and the resistance of the company's products over time. Respecting the rules of maintenance and use, specified as follows, will ensure the success of these objects, which were devised with Sclaro quality, to last a long time.

The information contained in this brochures or other Sclaro's advertisements prints, such as product specifications or components, dimensions, assembling instruction, colours, etc., are purely indicative, because of the technical specifications and the technological evolution of the company's products. In order to improve the quality of the product, the company reserves the right to change the same without prior notice and even after acceptance of the order. The company reserves the right to make partial or complete changes to the products without prior notice and declines any responsibility for inaccurate data. Any colour differences and changes of finishing have to be considered normal characteristics of the materials used. These differences do not significantly change the products and aren't reason for return or replacement of the goods or dispute.



## Synthetic fabrics: Acryl and Polyester

The fabric is waterproof and anti mould treated to reject water, spots and grant transpiration. Please follow our maintenance instruction to grant the long lasting of the fabric:

- Remove often dust deposits, spots and any type of dirt in order to avoid trails after cleaning.

- It's very important to close the parasol only when it is perfectly dry. During the winter and when the parasol is not employed, it has to be stored in dry environment.

Avoid prolonged contact with oily substances and/or dyes that could be absorbed by the covering material in PVC and cause permanent stains, in addition to damaging the structure of the thread. Do not use solvents or solvent-based detergents (avoid acetone).

Use water and non-abrasive, colourless liquid detergents with a neutral PH. Let the detergent act for a few minutes. Rinse well with water no warmer than 30°C.

## Components

The steel components, screws and accessories are anti rust treated. Anyway for a long lasting of the parasol, during the winter and when the it is not employed, the parasol has to be stored in dry environment.

During every season it is necessary to check the functionality of all components, especially after a long period of non-employ.

The company Scolaro is at your disposal for technical assistance.

## Directions

- Before use, directions and assembling instructions, which are inside the package, have to be kept and read carefully .

- The base has to be ballasted. An insufficient weight will seriously compromise the stability of the parasol.

- Always remove crank when not in use and keep out of reach of children.

- To avoid damage or personal injury, parasol must be closed and removed from the support when unattended and/or in windy conditions.

Remember always that the parasol is not a fixed construction. The company Scolaro cannot be held responsible for damages to goods supplied, or injury resulting from improper use and failure to follow instruction and guidelines given on.

## Product Employ

Before starting to open the umbrella, make sure that the fabric has not got caught in the internal ribs. To open or close the umbrella, turn the handle in the direction indicated by the arrows and the works "Open" or "Close". Incorrect operation could tear the string or damage the mechanism. Never force the ropes or handles. If they get stuck, check why this has happened and eliminate the possible cause.

Wooden parts: apply a wax-based wood-stainer at least once a year before the winter season.

Close the umbrella when the weather conditions are unsuitable, i.e. strong wind or heavy rain.

Scolaro umbrellas can be combined with special bases developed for the ground fixing.

If it is decided to position a Scolaro umbrella using ballast only, their suitability for use in conditions of moderate wind is certified.

In the specific table the minimum ballast weights are indicated.

The Customer is the sole party responsible for installing and managing the umbrella.

## Warranty

**Scolaro's products are guaranteed for 2 years:**

- structural faults not resulting from improper use or lack maintenance.

- invasive corrosion not produced by scratches or abrasions from use not removable through normal cleaning and maintenance.

The warranty is limited to one year for the opening mechanisms.

To take advantage of the warranty the faulty item must be shown or pictures must be forwarded, together with the invoice or receipt. Scolaro will not be liable for any damage to properties or individuals deriving from an improper use of the product.

The warranty includes the supply of spare parts or the replacement of the product if necessary. The warranty does not include the repair on-site or the refund of costs incurred for non-use of the product.

The new range of acrylic fabrics provide excellent color resistance to UV and a long life.

New range acrylic fabrics: They are guaranteed by Scolaro for a period of five years following a normal exposure to sun, sun's action and weathering.

The warranty does not cover damages caused by mechanical actions, malicious acts and acts of God. Therefore tissue damages such as cuts and abrasion, not recorded at the time of delivery or due to misuse, are excluded from warranty.

For more information please require the general warranty conditions.

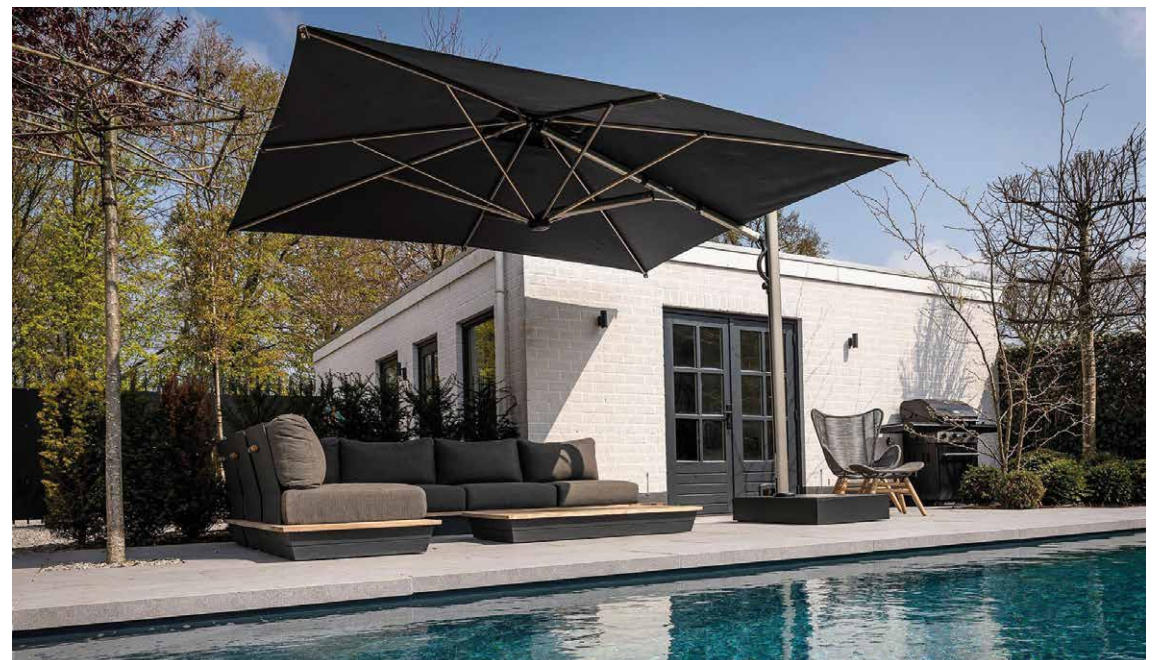
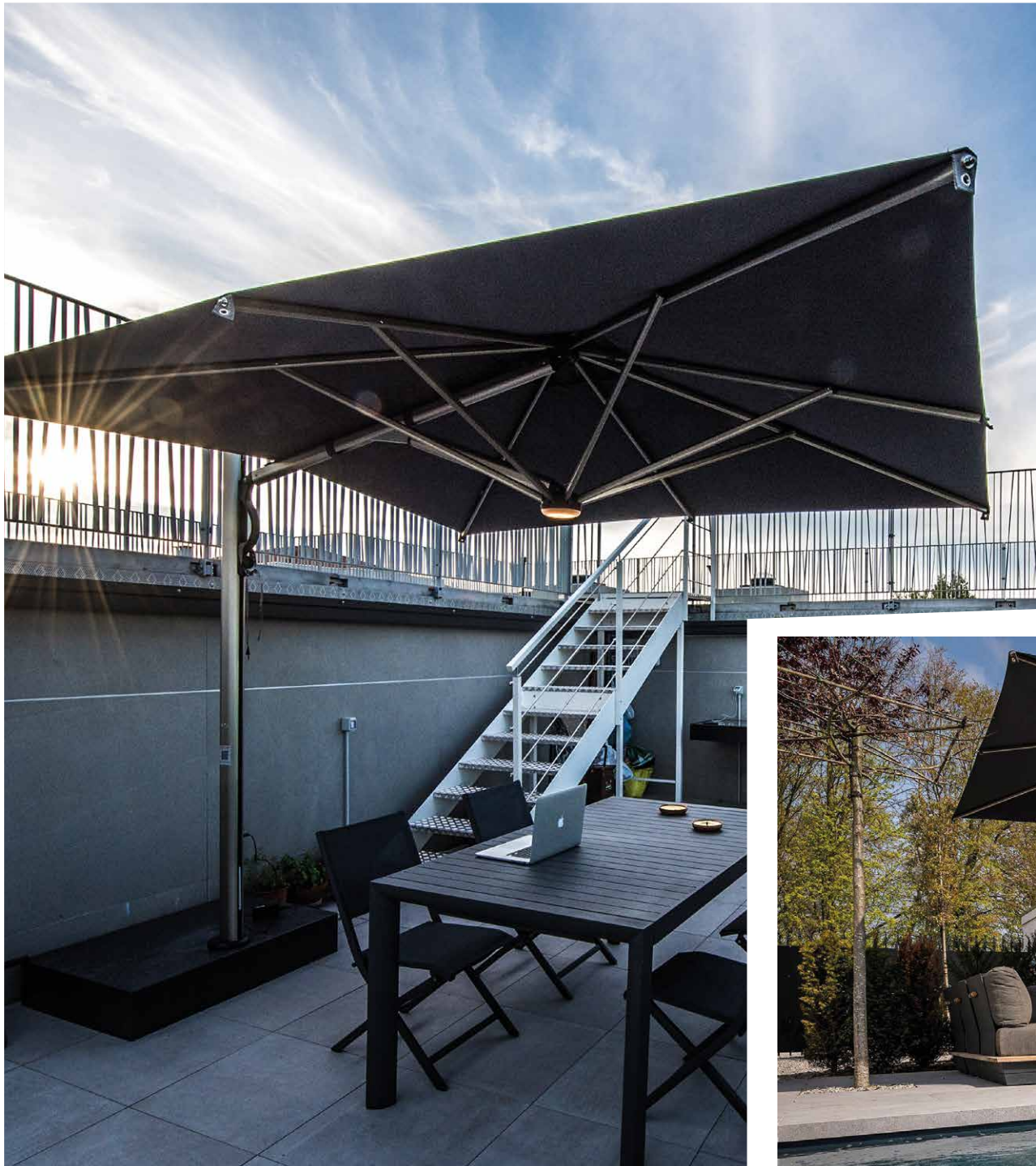

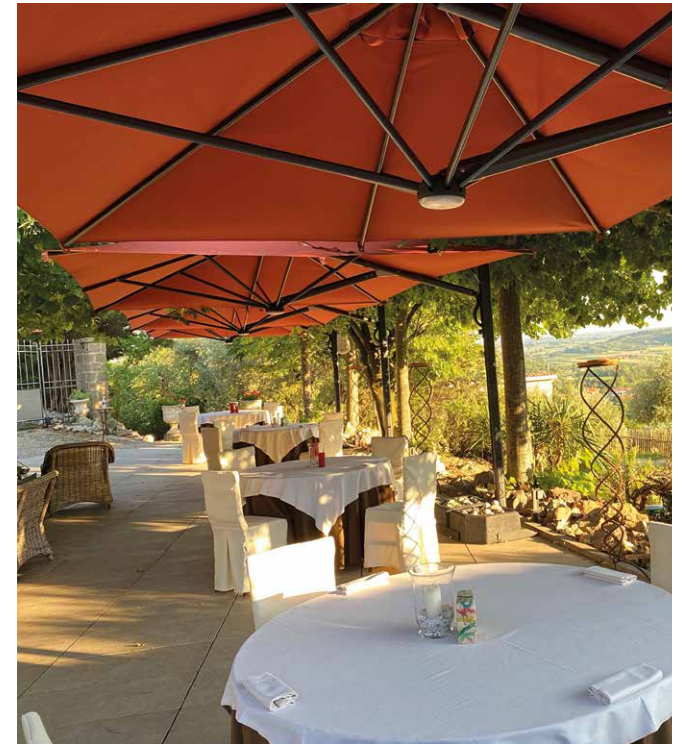
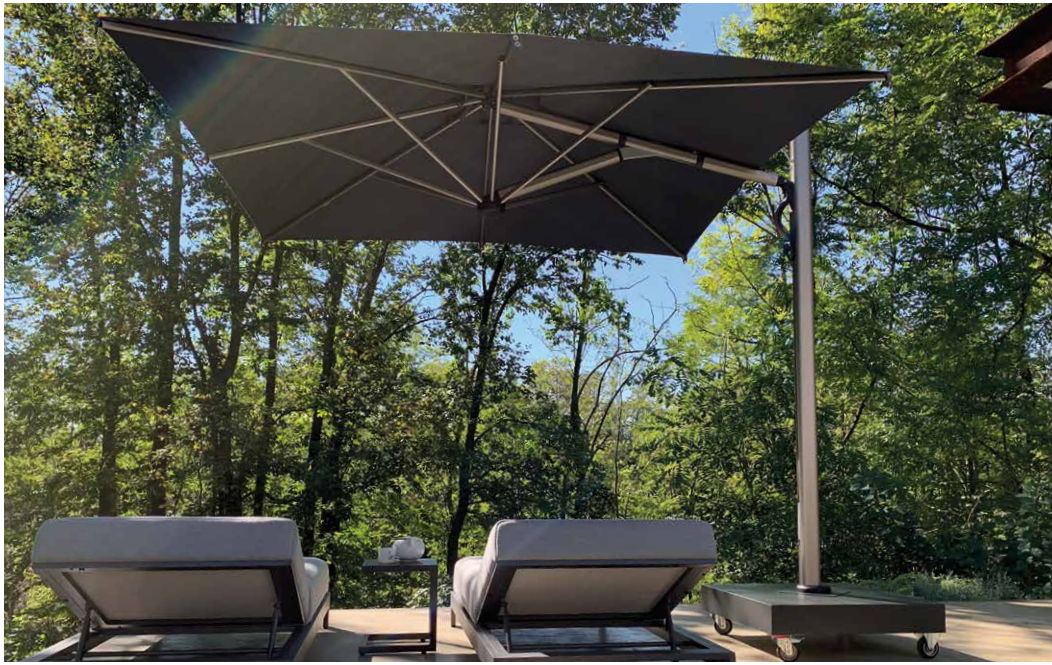

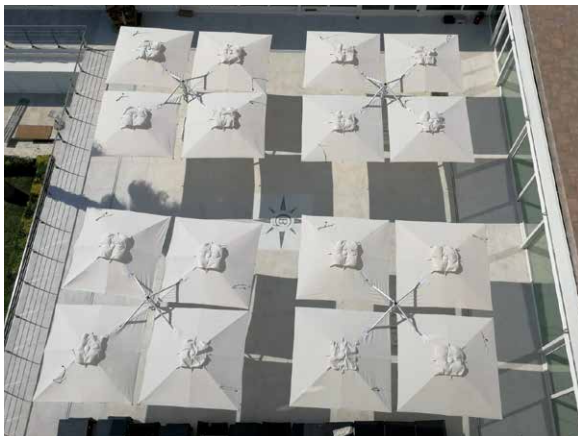

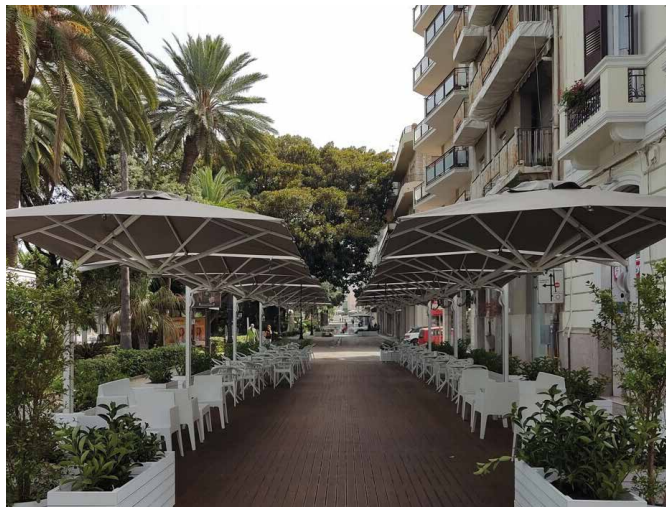
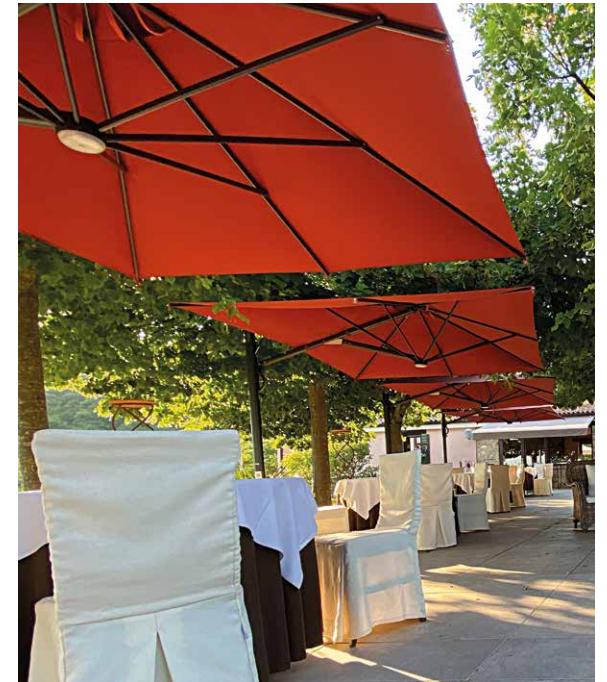

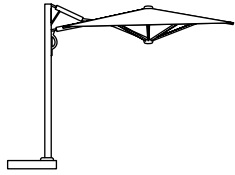

		BASES					
		N° 2 BC5151	N° 4 BC5151	N° 2 BV5050	N° 4 BV5050	BUD8080 + N°12 BC4040	FISSAGGIO A TERRA GROUND FIXING
ASTRO	3,0 x 3,0	/			/		
	3,5 x 3,5	/			/		
	3,0 x 4,0	/			/		
DUAL T	3,0 x 6,0	/		/			
	3,5 x 7,0	/		/		/	
DUAL V	3,0 x 6,0	/		/			
QUATTRO	6,0 x 6,0	/		/			

I  
 Queste tabelle sono indicative e prevedono che il pavimento o il terreno di appoggio sia perfettamente piano e regolare. Gli ombrelloni e i rispettivi componenti delle basi devono essere assemblati correttamente rispettando le istruzioni di montaggio. La stabilità degli ombrelloni può variare nel caso di condizioni atmosferiche particolari. L'utilizzatore finale è responsabile del corretto uso dell'ombrellone. Nessuna rivalsa può essere fatta sul produttore.

UK  
 This schedule considers statics calculation and foresees that the floor where the parasol has to be positioned is perfectly flat and regular. The parasols and components have to be assembled correctly and respecting the assembly instruction. The schedule has to be considered indicative because many variables that depend from the area of employ and position of the parasols are not foreseeable. No rights can be derived from this. The use of a parasol is always on your own responsibility.

D  
 Diese Aufstellung beinhaltet statistische Kalkulationen und sieht vor, dass der Schirm auf einem ebenen und regelmaessigen Boden positioniert wird. Der Schirm und die Bestandteile des Staenders muessen gemaess Anbauanleitungen montiert werden. Die Stabilitaet der Schirme kann auf Grund besonderer klimatischen Konditionen aendern. Der Endbenutzer ist fuer die ordnungsgemaesse Verwendung des Schirmes verantwortlich.

F  
 Ces tableaux sont à titre indicatif et ils prévoient que la surface sur laquelle est implanté le parasol soit parfaitement plane et lisse. Les parasols et les éléments respectifs des bases doivent être assemblés en respectant scrupuleusement les instructions de montage. La stabilité des parasols peut varier dans le cas de conditions atmosphériques particulières et dépend du lieu et de l'utilisation propre à chaque utilisateur (le parasol doit être fermé en cas de vent fort et/ou de mauvaises conditions météorologiques).

E  
 Estos cuadros son indicativos y requieren que el suelo o el apoyo de tierra sea perfectamente plano y liso. El parasol y los respectivos componentes de la base deben ser montados correctamente respetando las instrucciones. La estabilidad de los parasoles puede variar según las condiciones atmosféricas.

NL  
 This schedule considers statics calculation and foresees that the floor where the parasol has to be positioned is perfectly flat and regular. The parasols and components have to be assembled correctly and respecting the assembly instruction. The schedule has to be considered indicative because many variables that depend from the area of employ and position of the parasols are not foreseeable.



.Dimensione (metri)  
 .Dimensions (meters)  
 .Masse (Meter)  
 .Dimensions (metrès)  
 .Dimensiones ( en metros)  
 .Afmeting in (meters)



.Stecche  
 .Ribs  
 .Streben  
 .Baleines  
 .Varillas  
 .Baleinen



.Sistema retrattile  
 .Retractile system  
 .Einziehbares System  
 .Système retractile  
 .Sistema retráctil  
 .Inklapbaar systeem



.Massima Stabilità Ottenibile  
 .Maximum Obtainable Stability  
 .Maximal Erhaeltliche Stabilitaet  
 .Maximum De Stabilite Realisable  
 .Maxima Estabilidad Posible  
 .Maximaal Bereikbare Stablieit



.Codice  
 .Code  
 .Artikelcode  
 .Code  
 .Código  
 .Artikelcode



.Set canaline  
 .Raugutter set  
 .Regrinnen  
 .Set gouttières  
 .Canalizador Lluvias  
 .Set regengoten



.Piastre cemento  
 .Cement slabs  
 .Kiesbetonplatten  
 .Dalles ciment  
 .Planchas de cemento  
 .Betontegel



.Peso consigliato in condizioni normali  
 .Recommended weight in normal condition  
 .Empfohlenes gewicht unter normalen bedingungen  
 .Poids recommande dans des conditions normales  
 .Peso recomendado en condiciones normales  
 .Aanbevolen gewicht onder normale omstandigheden



.Lunghezza  
 .Length  
 .Laenge  
 .Longueur  
 .Longitud  
 .Lengte



.Con base/supporto  
 .With base/support  
 .Mit Staender/Huelse  
 .Avec base/support  
 .Con base/ soporte  
 .Inclusief standaard



.Stecca con sistema "easy change"  
 .Ribs with "easy change" system  
 .Streben mit "easy change" System  
 .Baleines avec "easy change" système  
 .Varillas con sistema de " cambio fácil"  
 .Baleinen met het "easy change" systeem



.Peso minimo richiesto  
 .Minimum ballast required  
 .Erforderliches mindestgewicht  
 .Poids minimum requis  
 .Peso minimo requerido  
 .Minimaal vereist gewicht



.Peso  
 .Weight  
 .Gewicht  
 .Poids  
 .Peso  
 .Gewicht

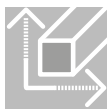

.Sezione stecche  
 .Rib section  
 .Strebenprofil  
 .Section baleines  
 .Sección varillas  
 .Profil baleinen



.Viteria in inox e ottone nichelato  
 .Screws in Stainless steel and nickel plated brass  
 .Edelstahlschrauben und vernickeltes Messing  
 .Visserie inox et laiton nickelé  
 .Tornillos en acero inoxidable y bronce niquelado  
 .Schroeven van rvs en vernikkeld messing



.Volume (m3)  
 .Volume (m3)  
 .Volumen (m3)  
 .Volume (m3)  
 .Volumen (m3)  
 .Volume (m3)



.Camino antivento  
 .Wind cap  
 .Windfang  
 .Souffle  
 .Chimenea antiviento  
 .Windvang



.Tipo finitura della struttura/sostegno/componenti  
 .Finishing for frame/structure/components  
 .Ausfuehrung des Gestells/der Struktur/der Bestandteile  
 .Finition armature/structure/composants  
 .Tipo de acabado de la estructura/Soportes/componente



.Sezione sostegno (mm)  
 .Support section (mm)  
 .Mastprofil (mm)  
 .Section support (mm)  
 .Sección soporte (mm)  
 .Mast (mm)



.Fodero  
 .Cover bag  
 .Schutzhuelle  
 .Housse  
 .Forro  
 .Afdekhoes



.Colore dei componenti/stecche  
 .Component/Ribs colour  
 .Farbe der Bestandteile und Streben  
 .Couleur des composants et baleines  
 .Color de los componentes ò piezas/Varillas ò listones





**SCOLARO PARASOL SRL**

Via Liguria, 197 - 35040 Casale di Scodosia (PD) - ITALY - TEL. +39 0429 656687

info@scolaro-parasol.it - www.scolaro-parasol.it



SCOLARO-PARASOL.IT

